



Fast ion instability studies at ATF

*Junji Urakawa (KEK) at ILC Damping Rings R&D
Workshop – ILC DR06, Cornell University*

1. *Introduction of ATF*
2. *Multibunch Emittance Study*
3. *Laser wire results*
4. *Turn by Turn and Bunch by Bunch beam
position measurement by the step of 100psec
for 1msec*
5. *Simulation by Lanfa*



ATF Introduction

Beam kick test at ATF

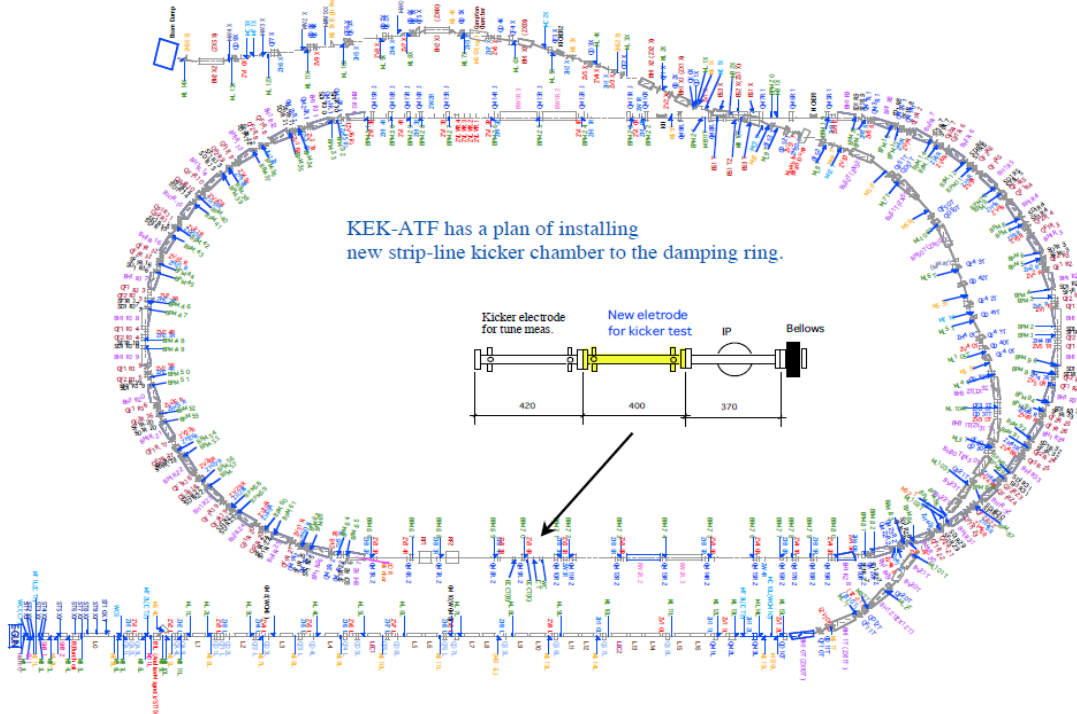

Emittance status

$$E=1.3\text{GeV}, \quad N_e=3 \times 10^{10} \text{ e-/bunch}$$

$$1 \sim 20 \text{ bunches}, \quad \text{Rep}=3.125\text{Hz}$$

$$X \text{ emit}=2.5 \times 10^{-6} \text{ (at 0 intensity)}$$

$$Y \text{ emit}=1.0 \times 10^{-8} \text{ (at 0 intensity)}$$

$$\rightarrow 2.5 \times 10^{-9} \text{ in Future}$$

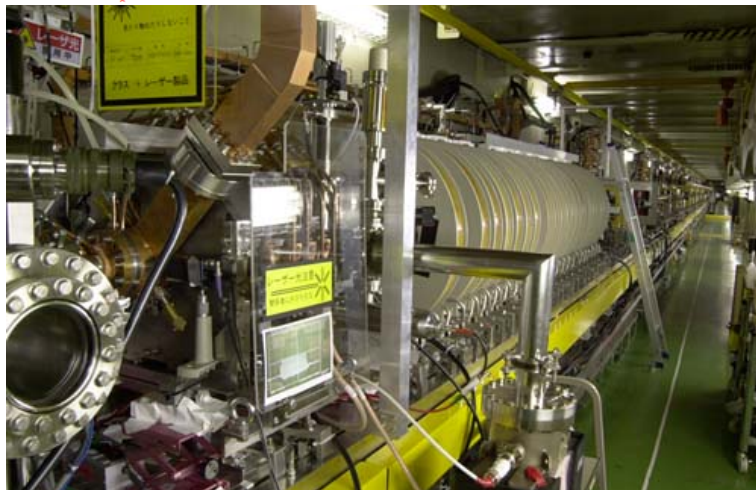



Multibunch emittance study

Monitors of MB emittance

MB (or projected) Laser-wire (bunch-by-bunch signal detection with gated circuit),

Projected SR interference monitor,

X-ray SR monitor,

MB (or projected) wire scanner:

(EXT-line coupling problem?)

Problem of MB emittance

Fast Ion Instability ? Longitudinal multi-bunch oscillation : Damped Cavity problem?



Preliminary result of Fast Ion Instability simulation

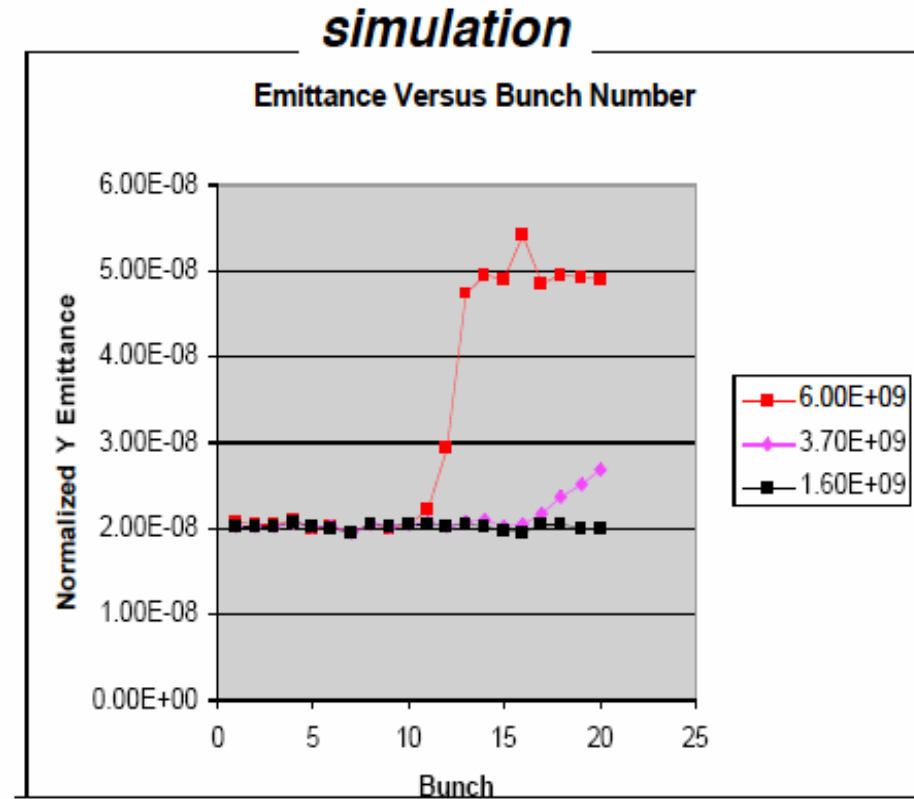
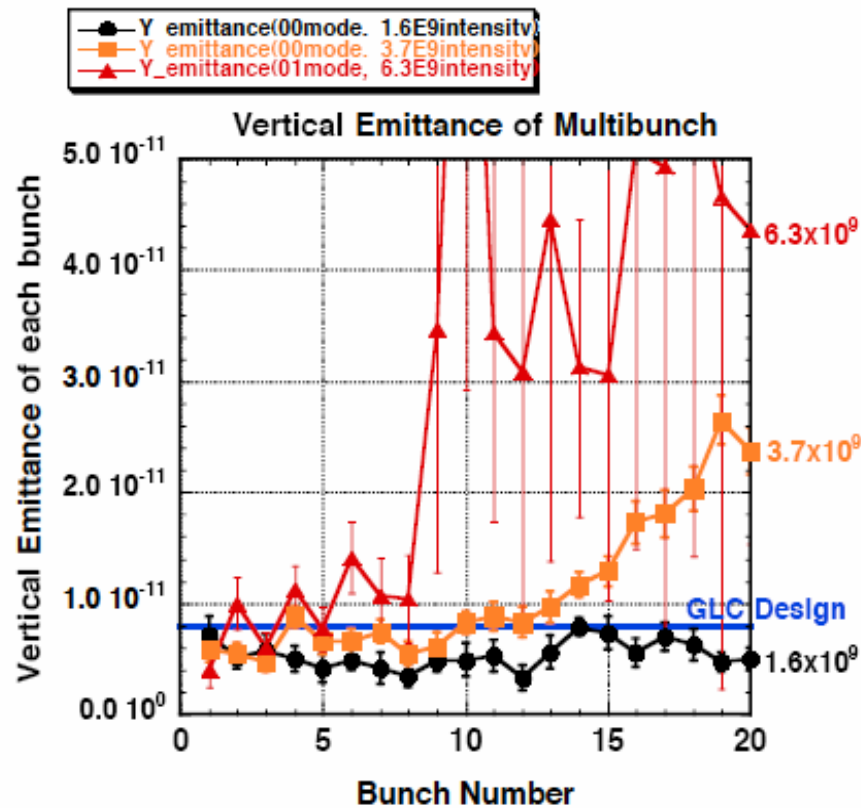

Behavior of Y emittance is very similar.

Tor's simulation in 2004.

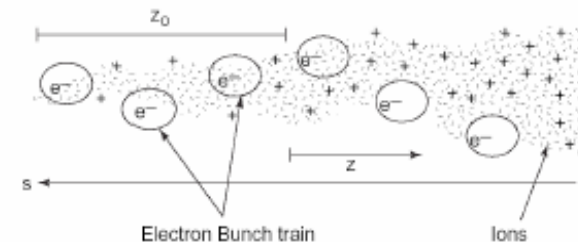

Schematic of the Fast-Beam Ion Instability



Scrubbing of DR example



60~70mA (20bunch, 3train);
1.3~1.5x10⁻⁶ pa --> 1.0~1.1x10⁻⁶ pa



Synchrotron Oscillation growth in 20 bunch

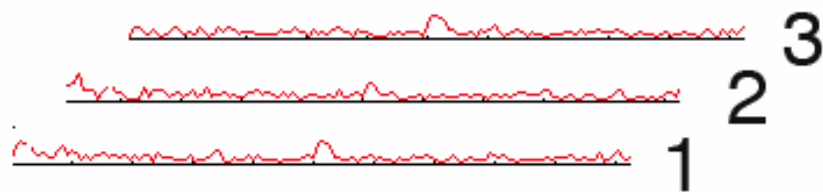
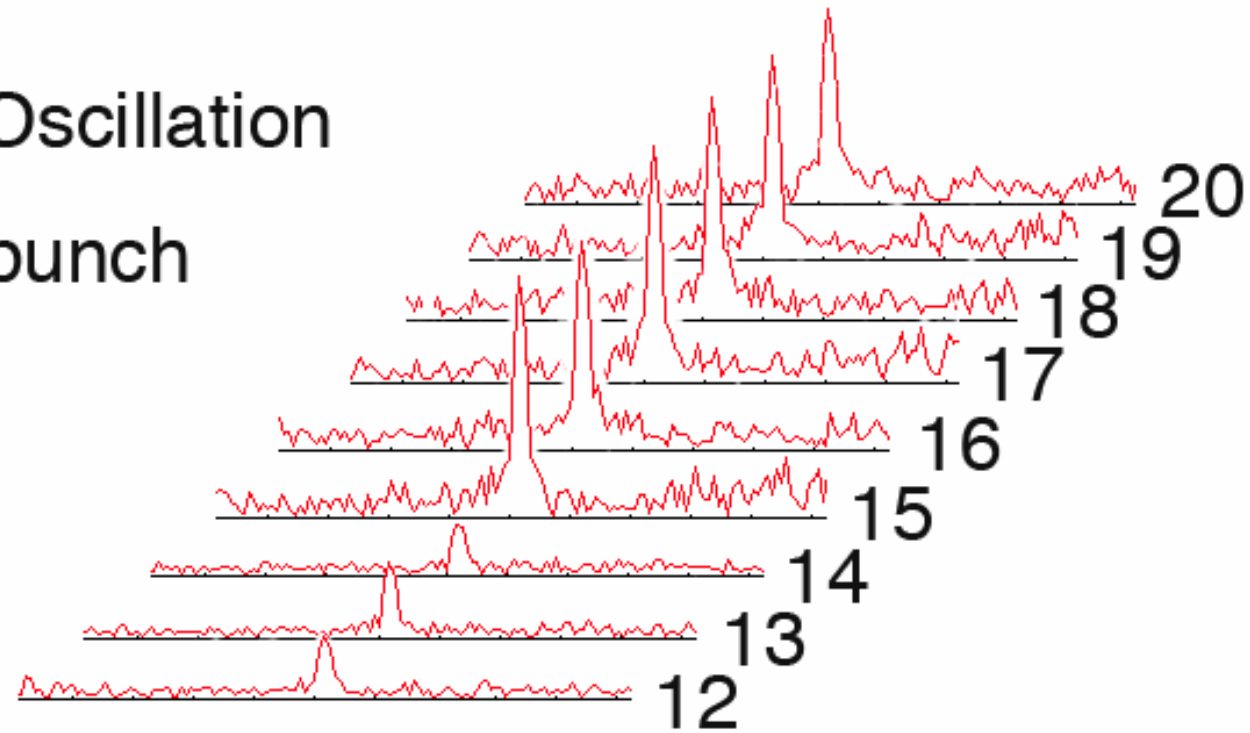

FFT spectrum
of Multi-bunch BPM data



ATF Damping Ring BPM

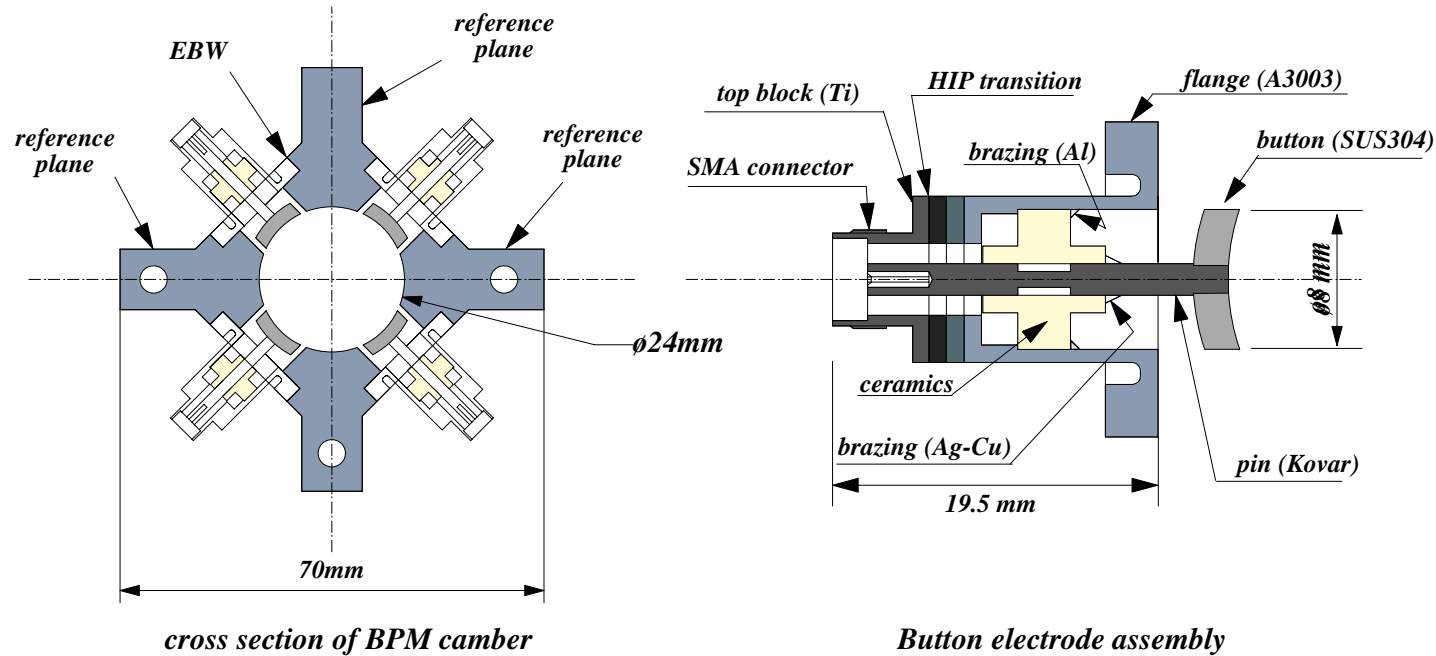

Button BPM for Damping Ring

Electronics: single pass detection for 96 BPMs



Spectrum of DR BPM

Resolution Improvement

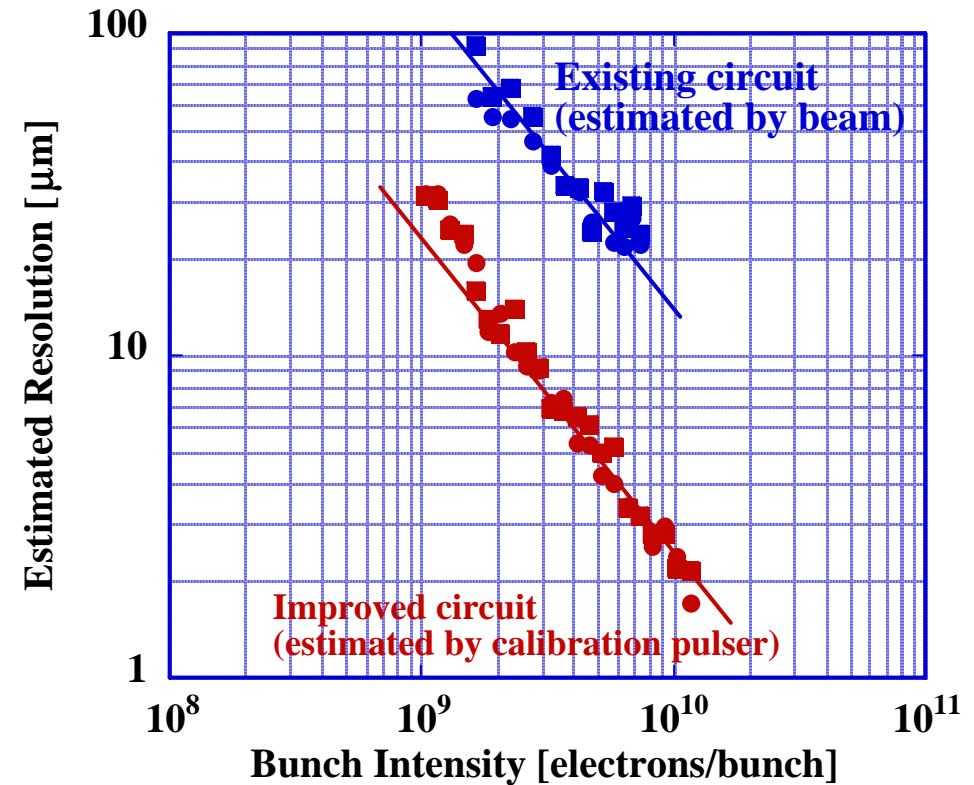
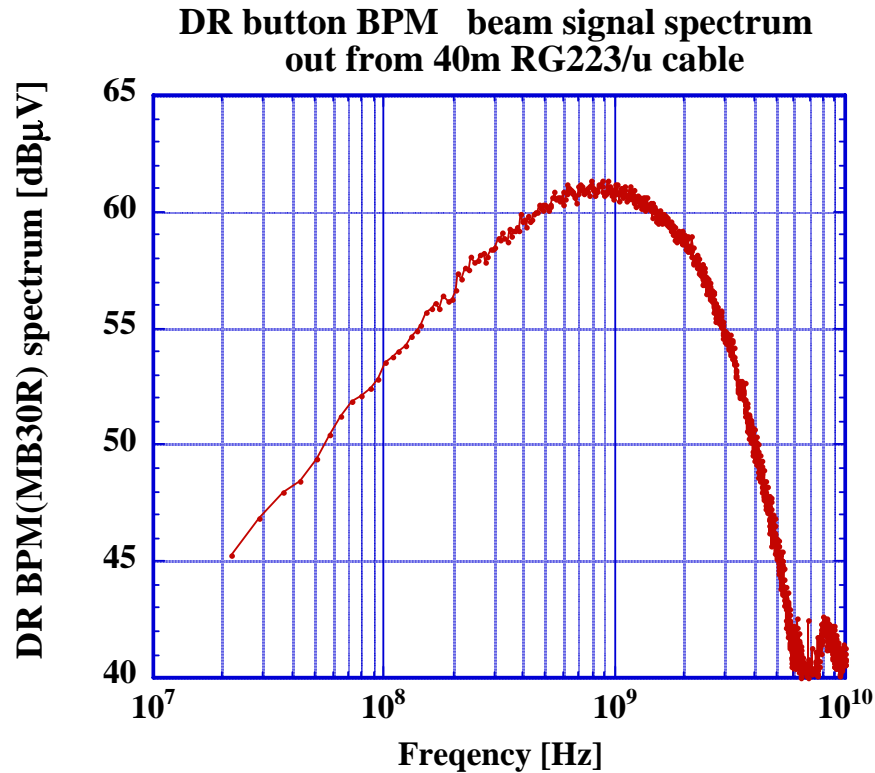

Signal peak at ~ 1GHz

Min. resolution ~ 2μm



Laser wire beam size monitor in DR

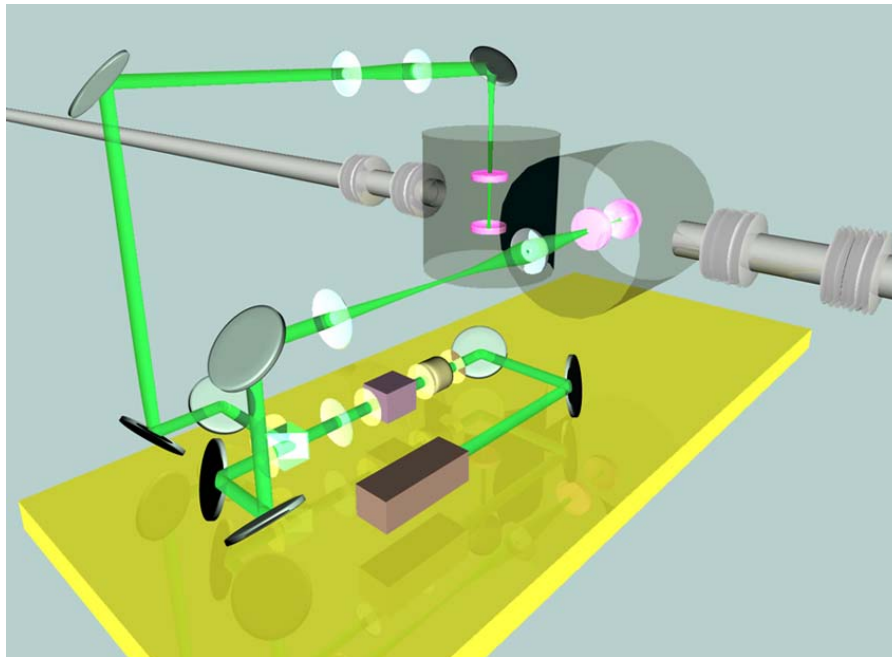

*300mW 532nm Solid-state Laser
Fed into optical cavity*

2006/9/28

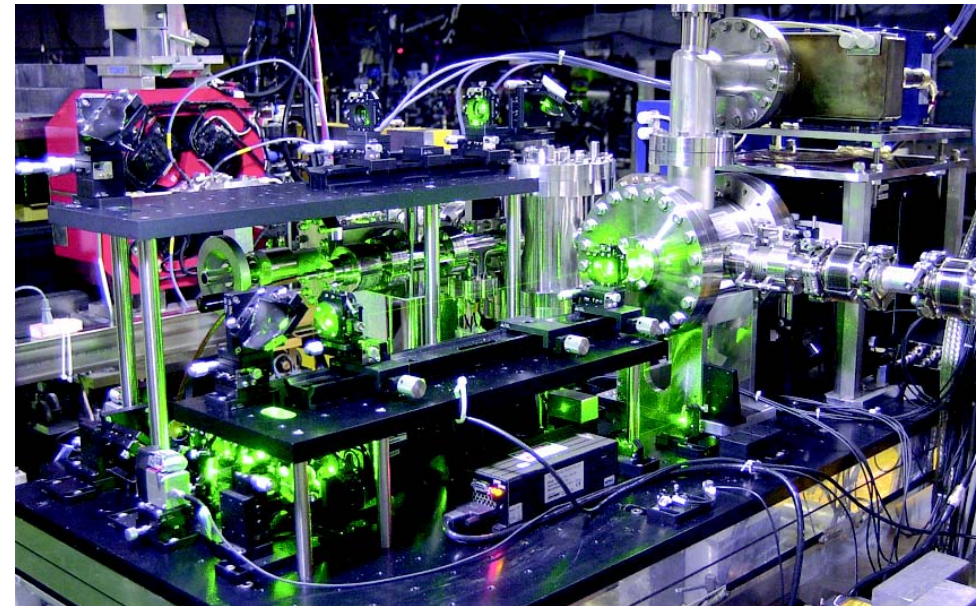

*14.7 μ m laser wire for X scan
5.7 μ m for Y scan
(whole scan: 15min for X,
6min for Y)*



Beam profile by Laser wire

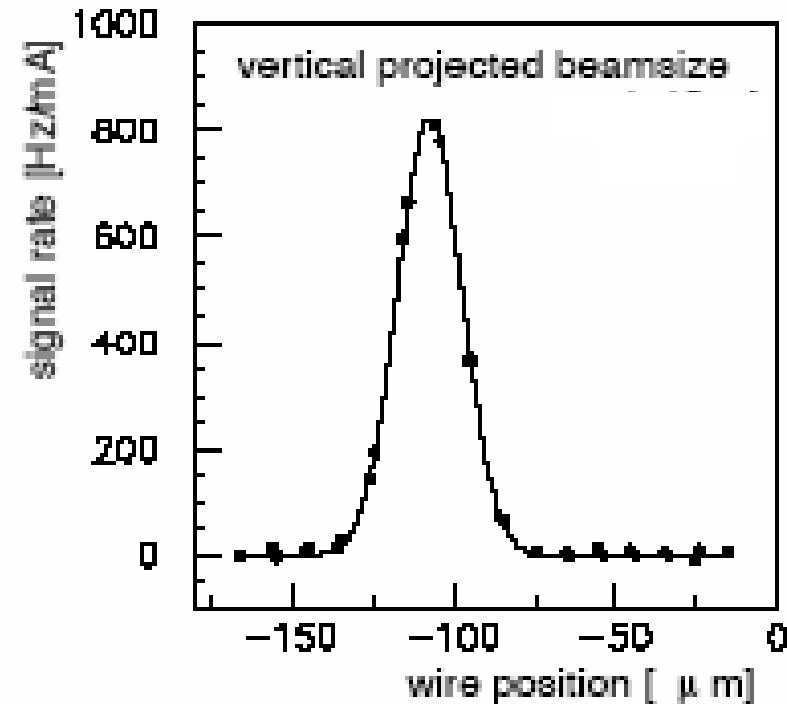
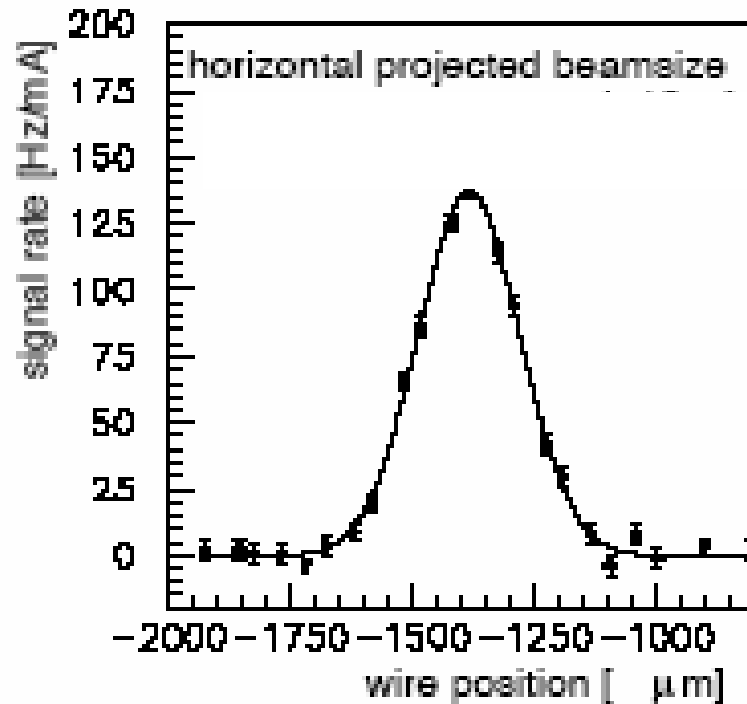

$$\sigma_e^2 = \sigma_{\text{meas}}^2 - \sigma_{lw}^2$$

$$\varepsilon\beta = \sigma_e^2 - [\eta(\Delta p/p)]^2$$

β : measured by Q-trim excitation



Emittance by Laser wire

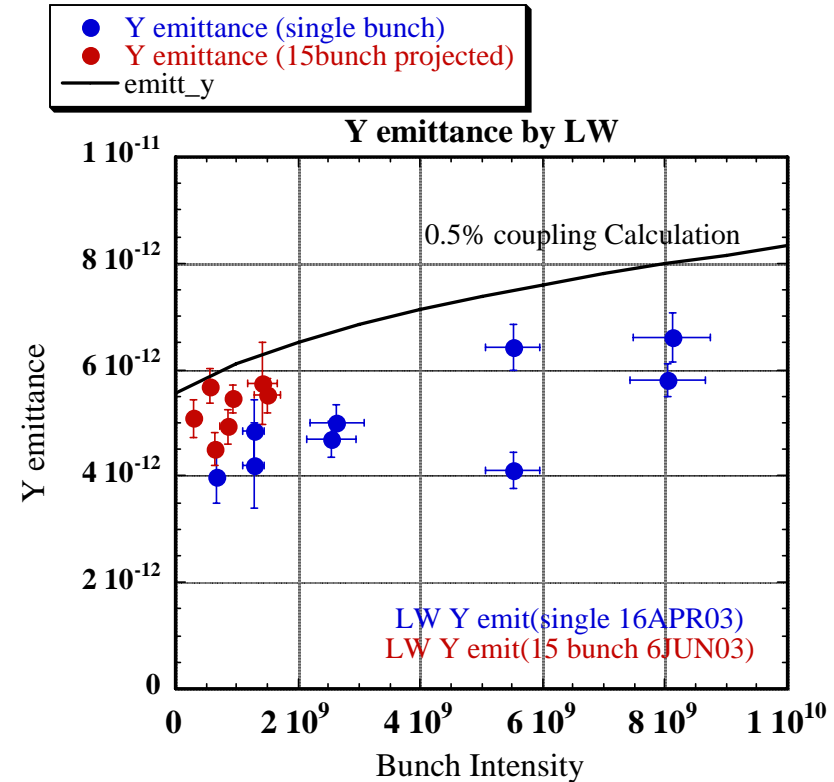
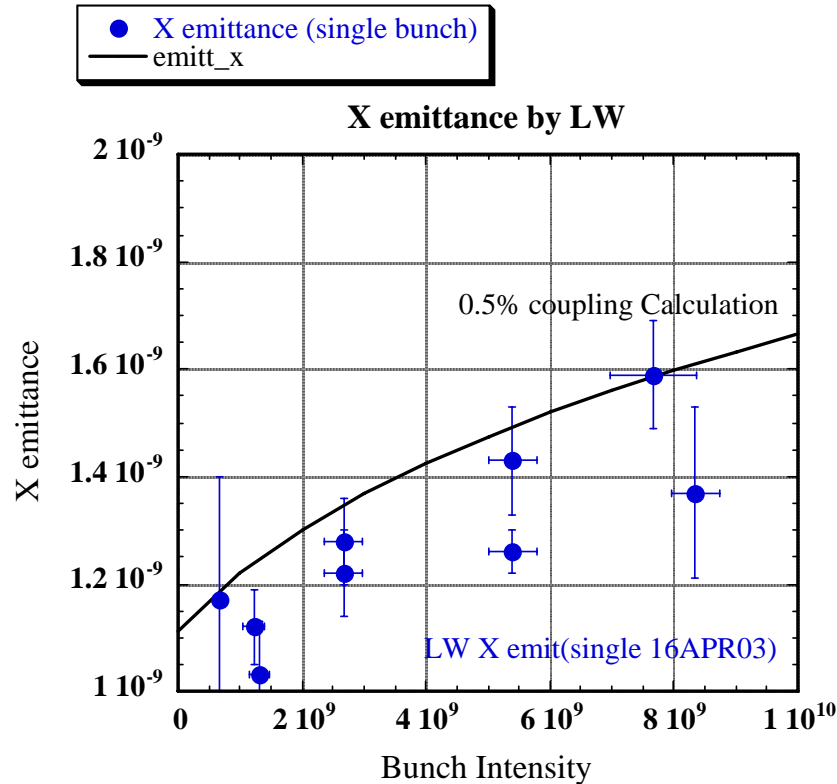

< 0.5% y/x emittance ratio

Y emittance = 4pm at small intensity

VOLUME 92, NUMBER 5

PHYSICAL REVIEW LETTERS

week ending
6 FEBRUARY 2004

Achievement of Ultralow Emittance Beam in the Accelerator Test Facility Damping Ring

Y. Honda,¹ K. Kubo,² S. Anderson,³ S. Araki,² K. Bane,³ A. Brachmann,³ J. Frisch,³ M. Fukuda,⁶ K. Hasegawa,¹⁴ H. Hayano,² L. Hendrickson,³ Y. Higashi,² T. Higo,² K. Hirano,¹³ T. Hirose,¹⁵ K. Iida,¹² T. Imai,⁹ Y. Inoue,⁷ P. Karataev,⁶ M. Kuriki,² R. Kuroda,⁸ S. Kuroda,² X. Luo,¹¹ D. McCormick,³ M. Matsuda,¹⁰ T. Muto,² K. Nakajima,² Takashi Naito,² J. Nelson,³ M. Nomura,¹³ A. Ohashi,⁶ T. Omori,² T. Okugi,² M. Ross,³ H. Sakai,¹² I. Sakai,¹³ N. Sasao,¹ S. Smith,³ Toshikazu Suzuki,² M. Takano,¹³ T. Taniguchi,² N. Terunuma,² J. Turner,³ N. Toge,² J. Urakawa,² V. Vogel,² M. Woodley,³ A. Wolski,⁴ I. Yamazaki,⁸ Yoshio Yamazaki,² G. Yocky,³ A. Young,³ and F. Zimmermann⁵

Experimental setup

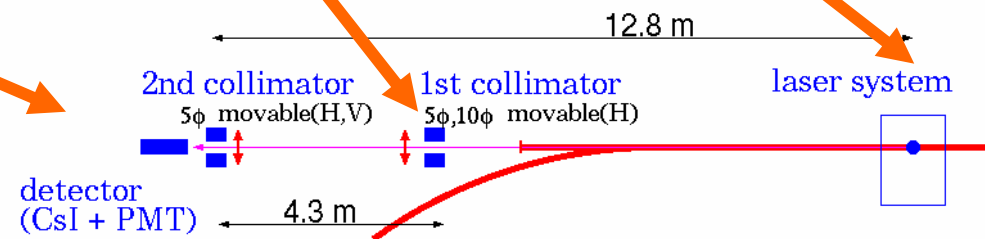
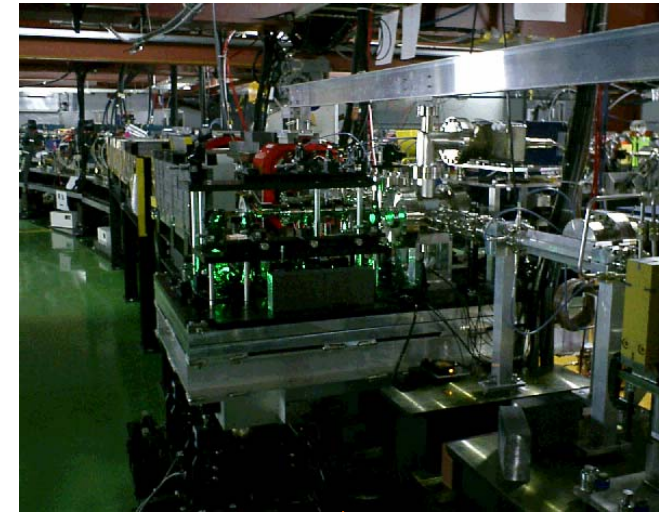
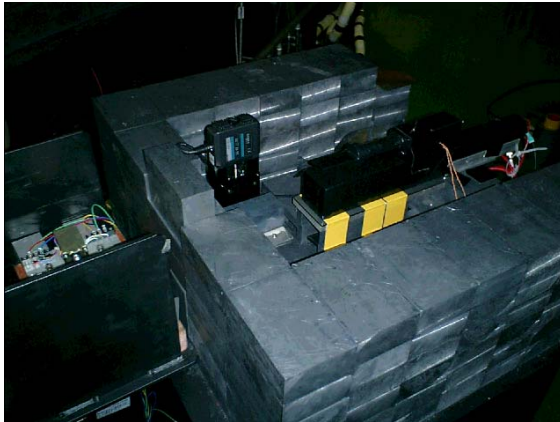

1. laserwire
2. detector and collimator
3. data taking system

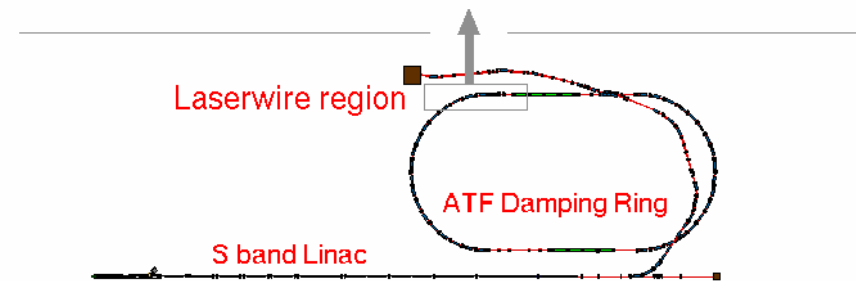

Laserwire setup

vertical wire

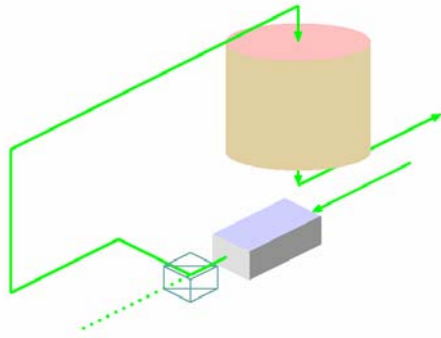

horizontal wire

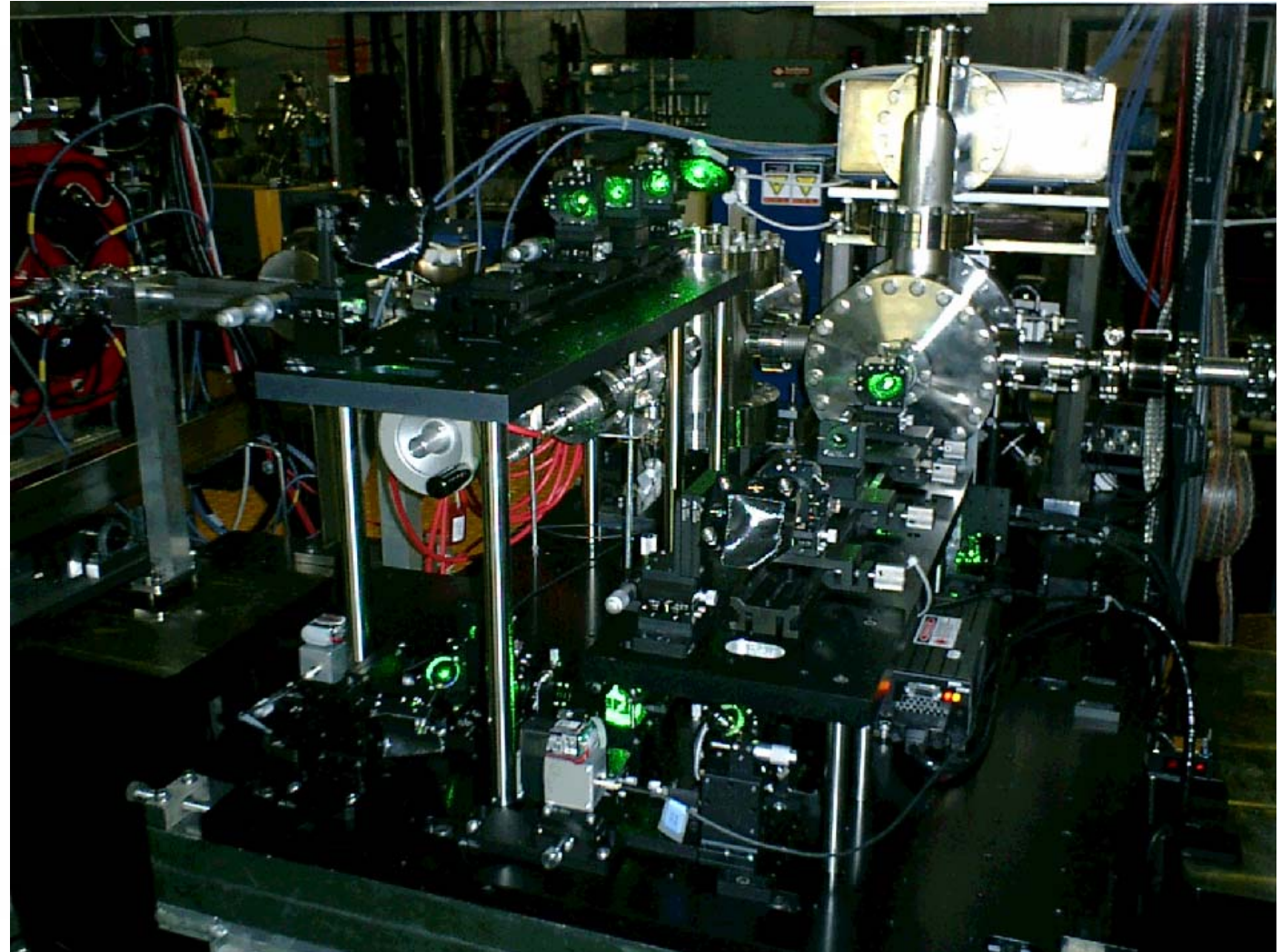
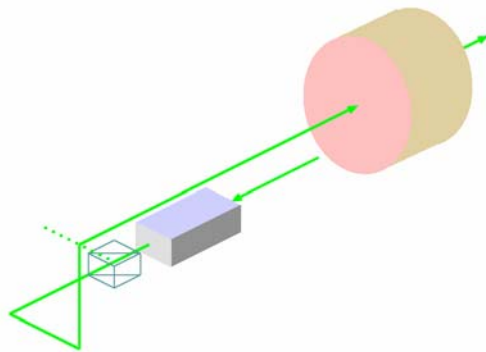

Detector

- Compton scattering
28.6 MeV (max gamma energy)
23.0 MeV (0.2 mrad scattering angle)

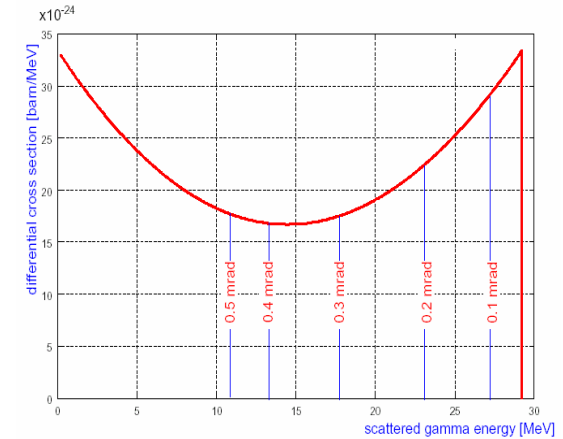

- gamma ray detector

[70 mm × 70 mm × 300 mm]

CsI(pure) crystal

2” photo-multiplier

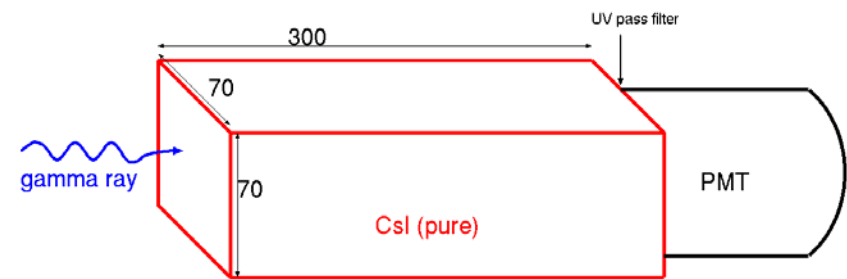

- time resolution

PMT signal leading edge

0.56 nsec resolution

(signal energy region)

enough to separate 2.8ns spacing bunches

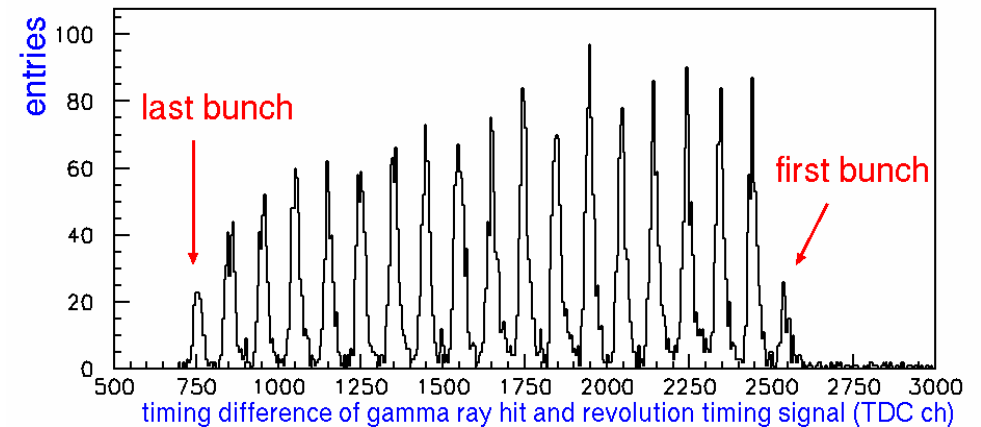



Beam damping measurement

- beamsize measurement as a function of storage time

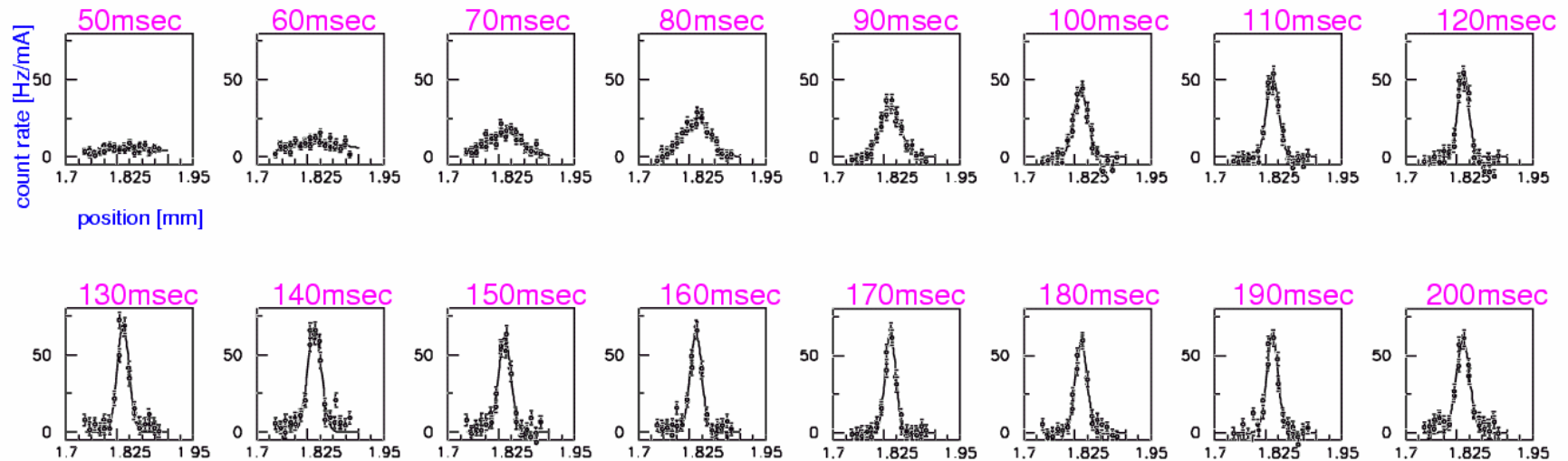
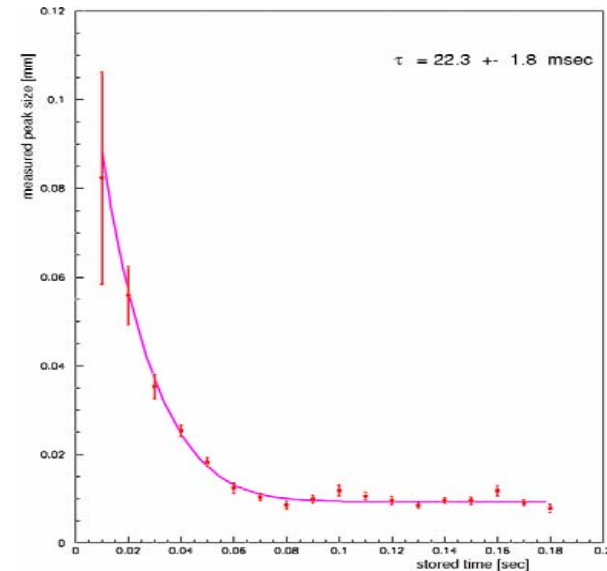

New powerful data acquisition system will be installed in Nov..

**Tektronix, DPO7000, 20GS/sec, 500MHz to 7.25GHz,
1msec continuous signal measurements just after triggering
by the step of 100psec for fast kicker study.**

Single kick result(Horizontal)

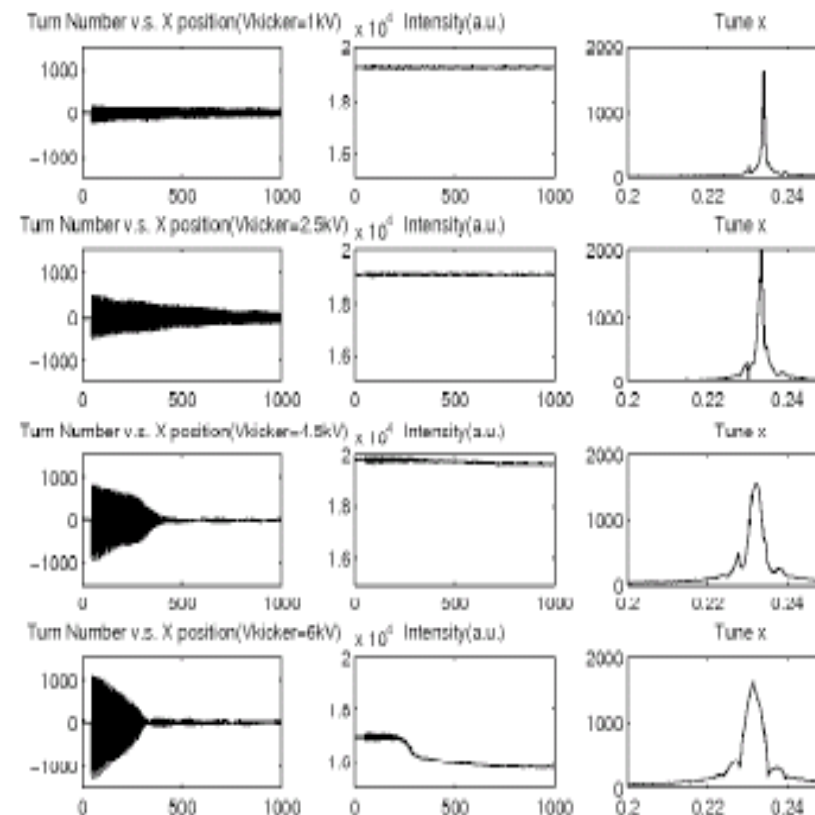



Single kick result(Vertical)

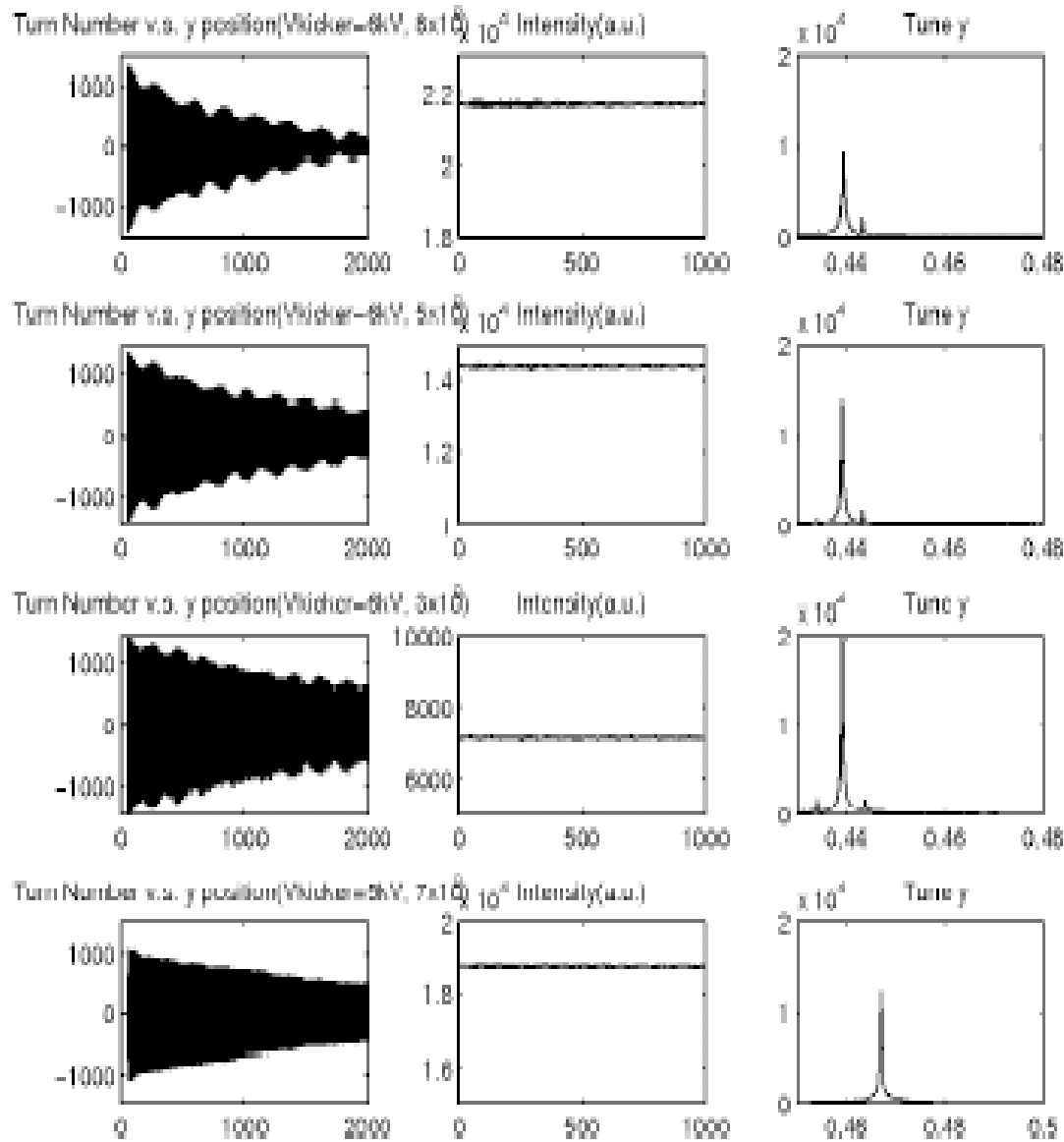



Fig.1, x vs. turn number for various initial kick angle,
0~300 turns

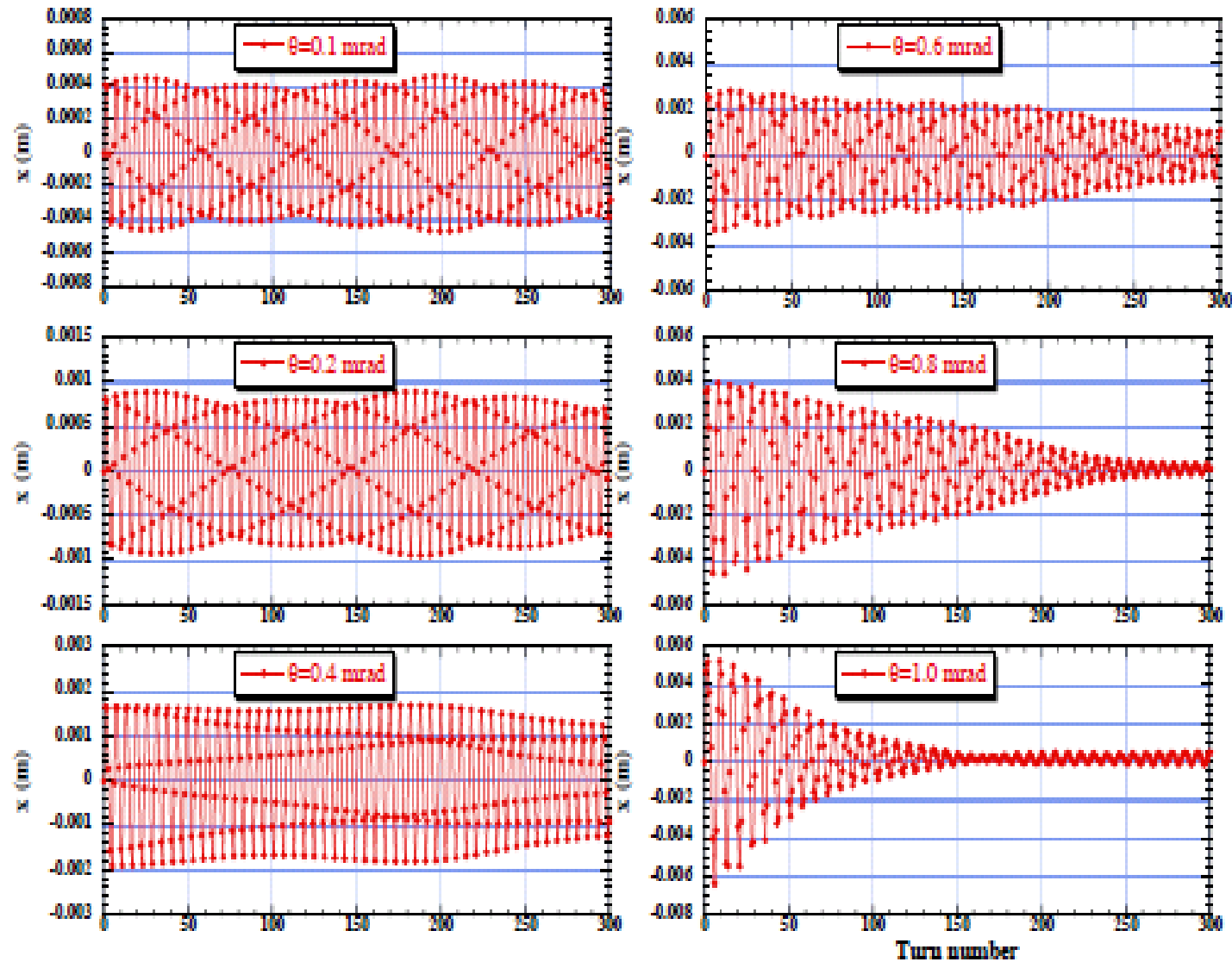



Fig. 3, Horizontal phase space distribution for large amplitude, turn 0 ~ 60

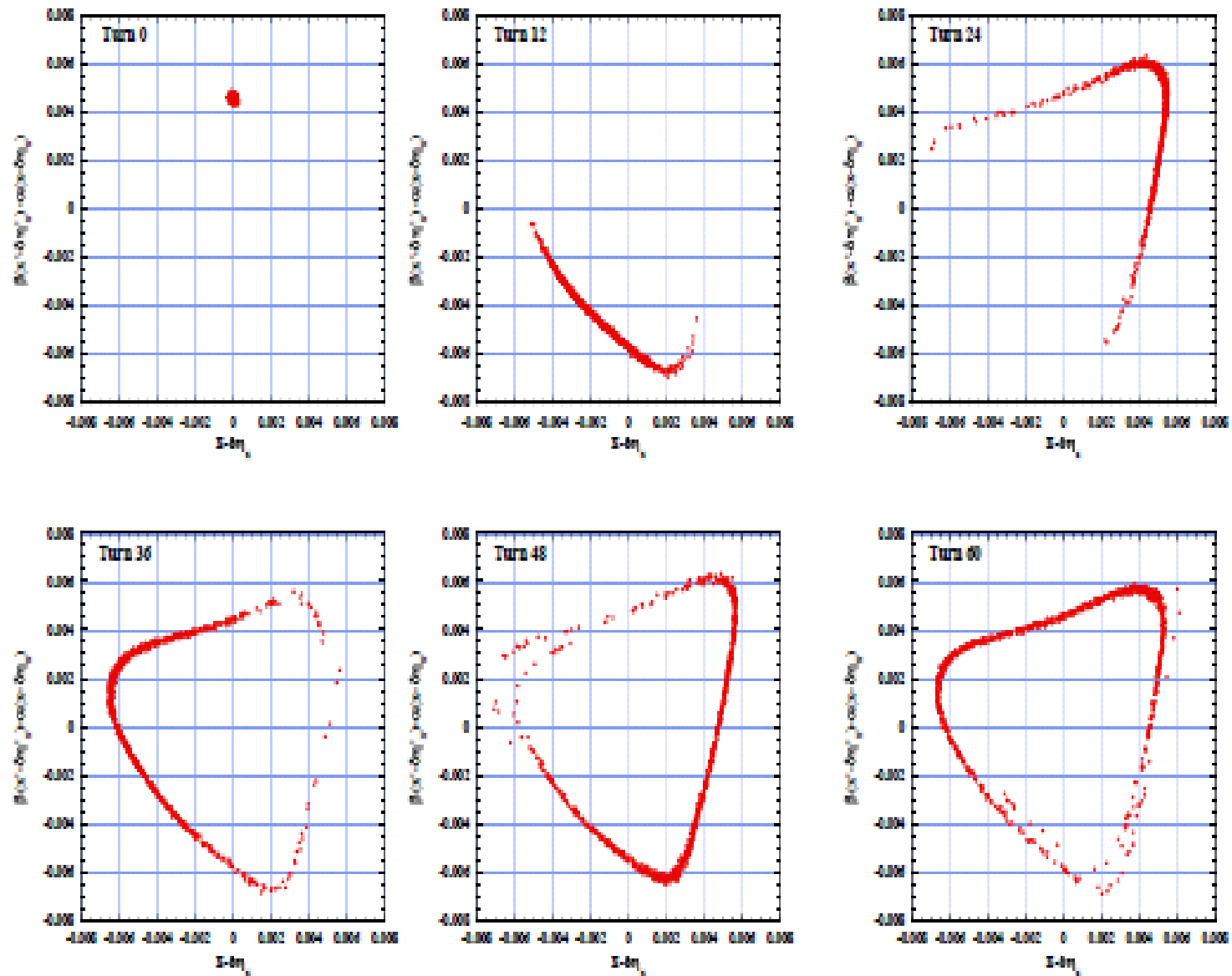
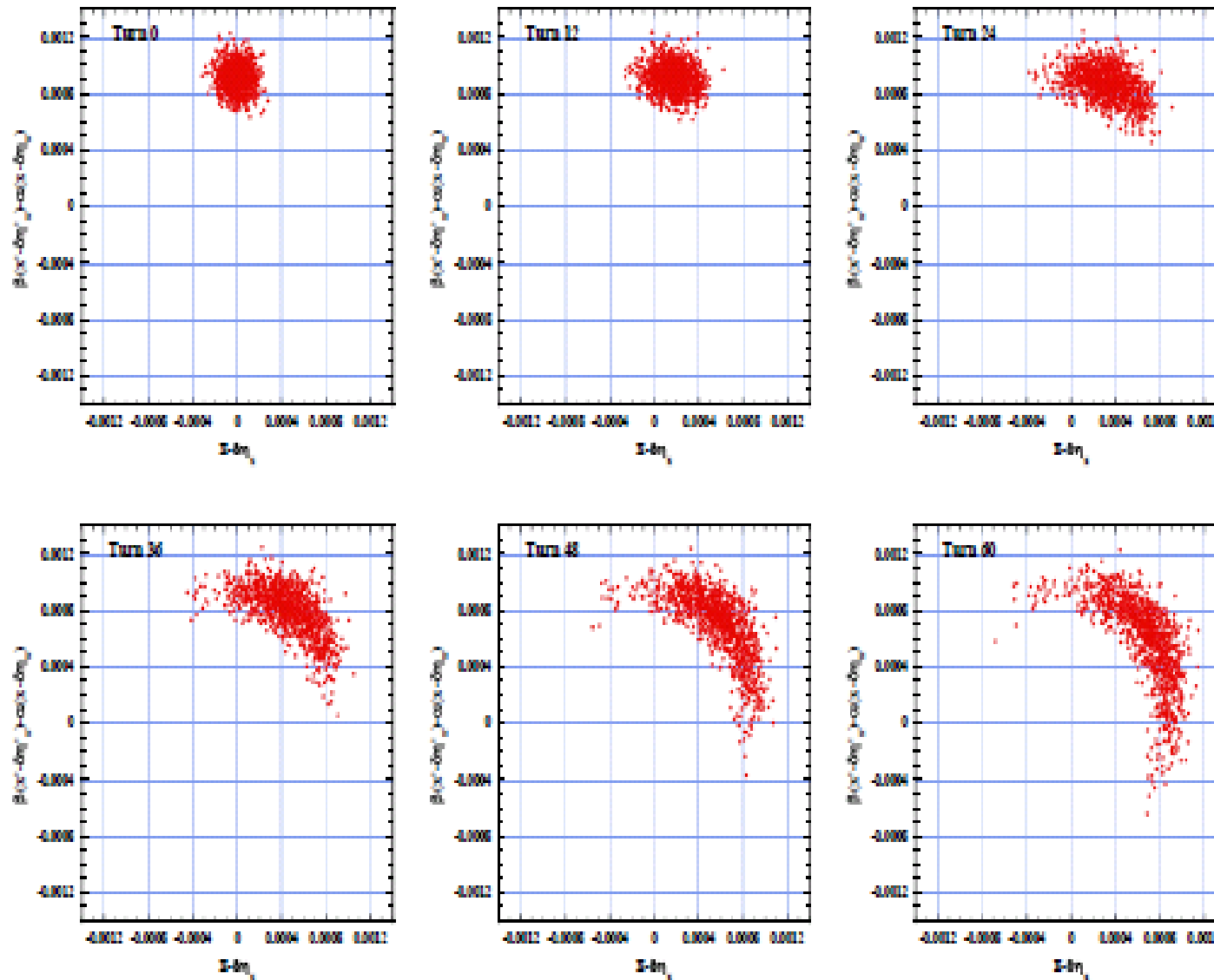



Fig. 4, Horizontal phase space distribution for small amplitude, turn 0 ~ 60





New powerful data acquisition system



DAQ which will be made soon

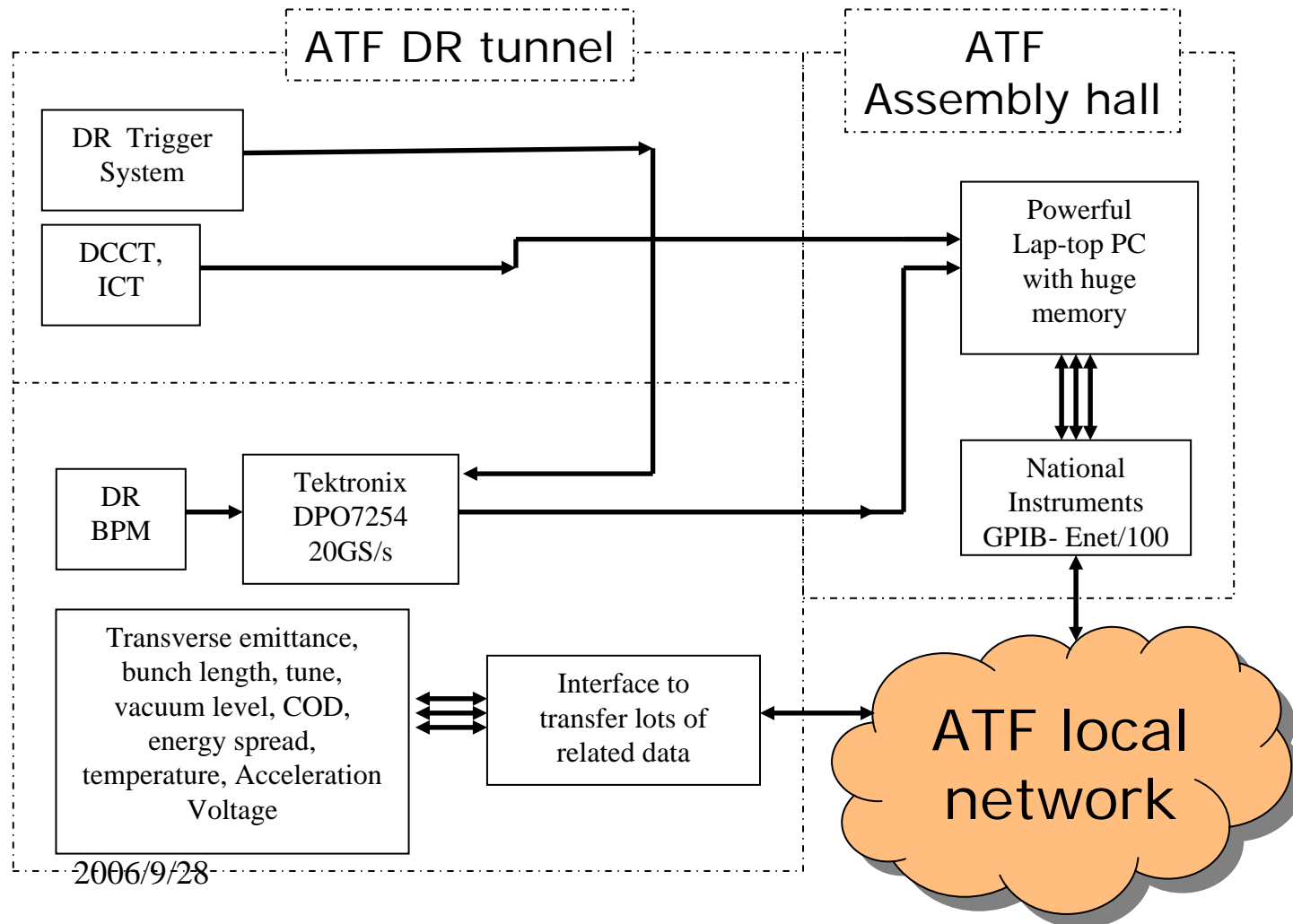



Lanfa Wang tried a simulation about FII at ATF. He used the similar parameters as Tor used. The optics is included. This is a weak-strong program, so only dipole oscillation can be simulated. **Preliminary**

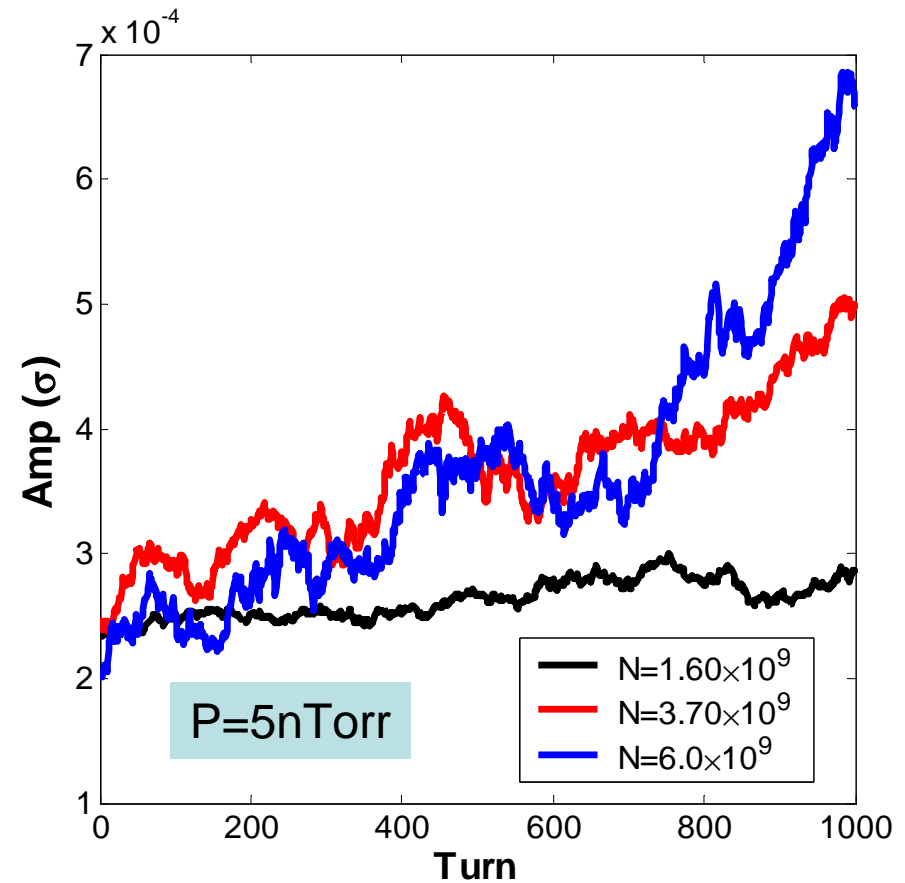
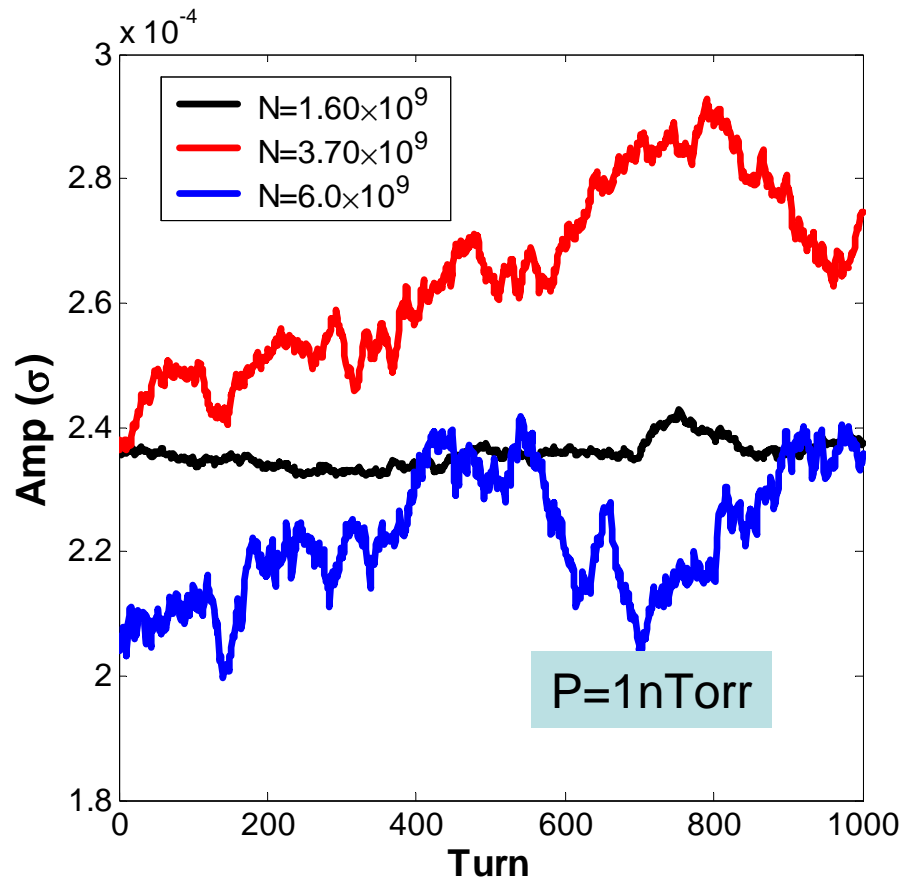

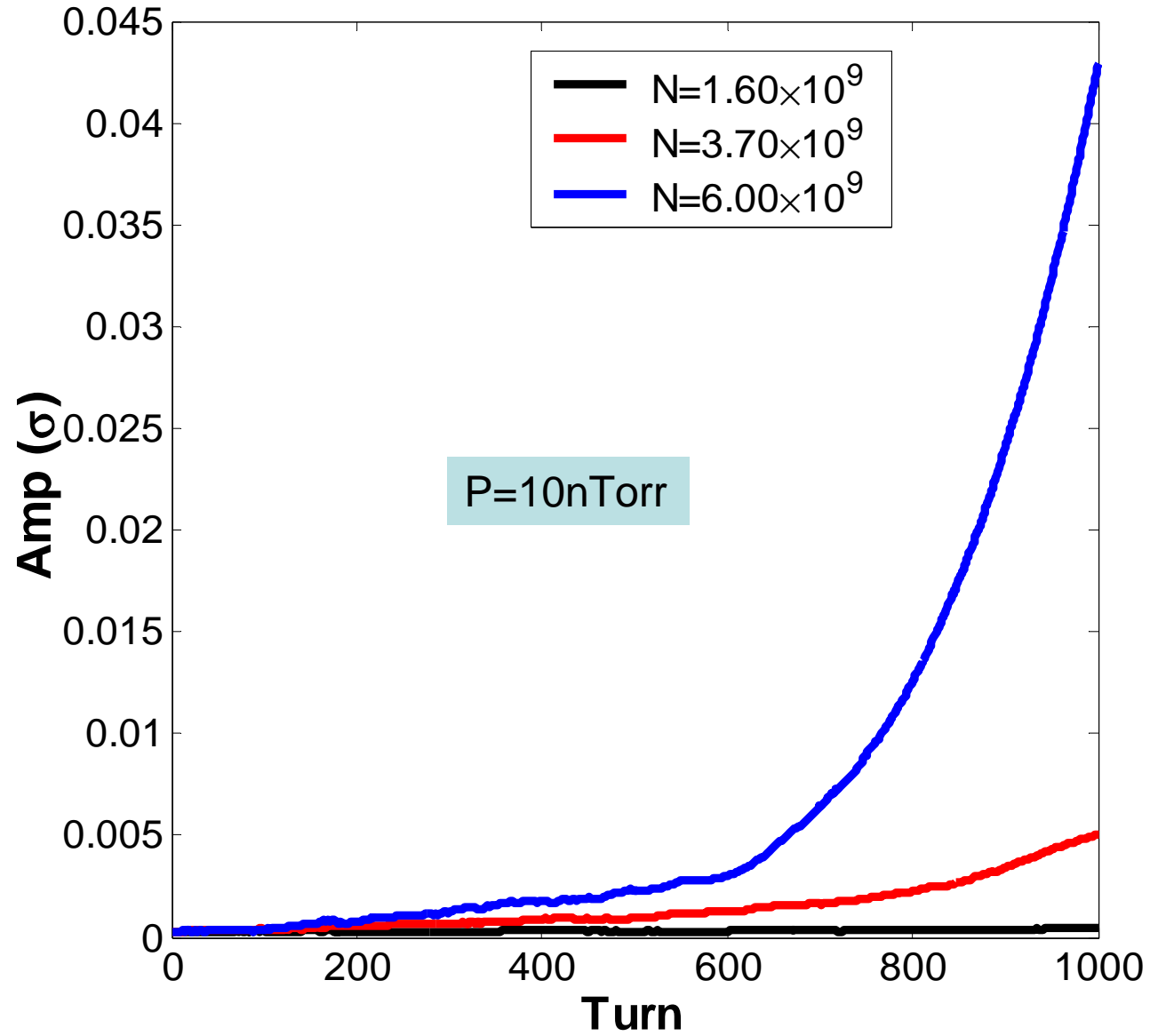



FII at ATF

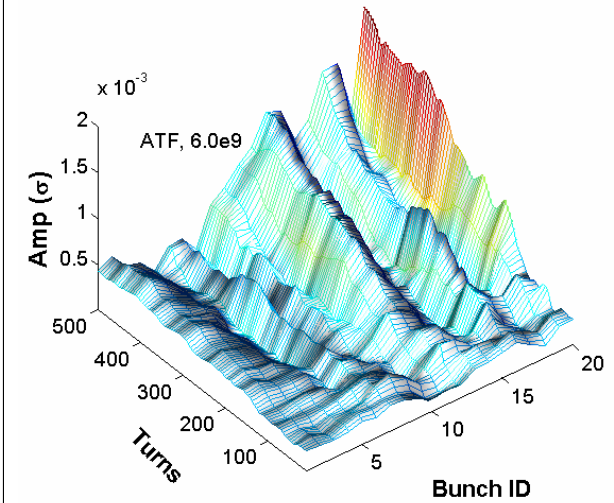
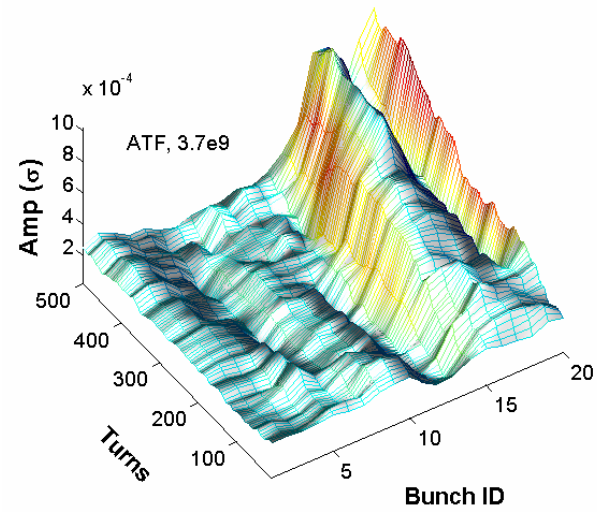
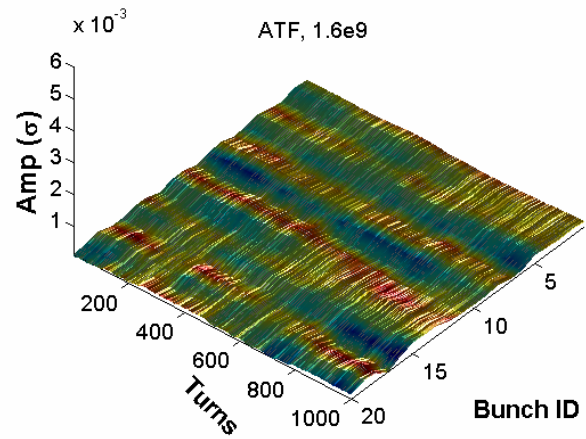

P=10nTorr



Experimental Plan for study on fast ion instability

The range from **several 10^9 to 3×10^{10} electrons/bunch**
Until 20 bunches/train, changeable from 1 to 20.
Precise emittance growth measurements bunch-by bunch.
Precise tune measurement versus the bunch intensity
**Accurate beam position measurement during 1msec by the
step of 100psec ; huge data will be obtained.**

Appropriate period is Jan., Feb. and March in 2007 because
all instrumentations require the check and fine tuning for three
months from now and fast kicker R&D has first priority.
Anyway, I want to finish the study of fast ion instability
within 2007 and 2008 at ATF.