

Laserwire at the ATF

Yosuke Honda

3rd Jul. /06

Oxford

- Quick introduction of optical cavity
- List of milestones we have achieved
- No new things

principle

- beam size measurement
 - scan by the mover stage of whole laser system
 - scattered photon counting
- requirements
 - thin laser width ($5\ \mu\text{m}$)
 - high effective power (100W)
- our solution
 - external optical cavity with a small waist
 - power enhancement
 - well defined laser profile

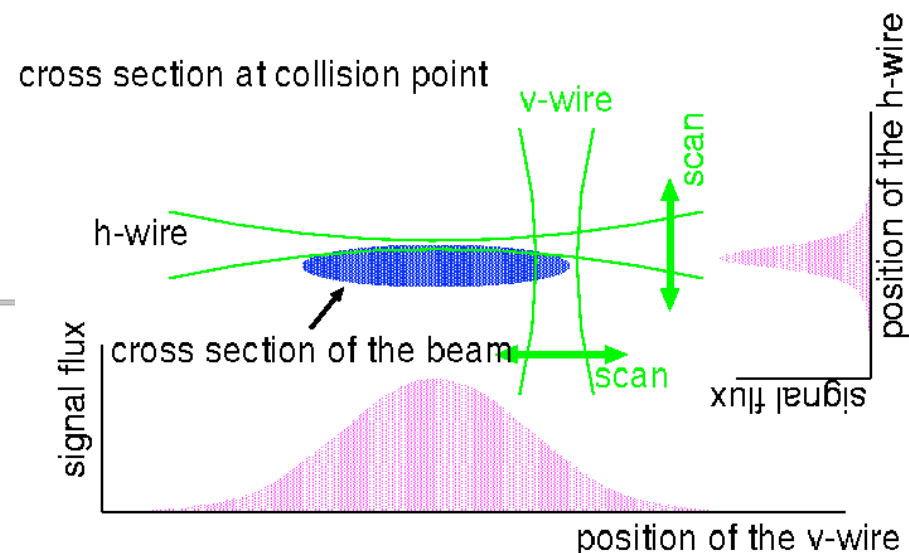
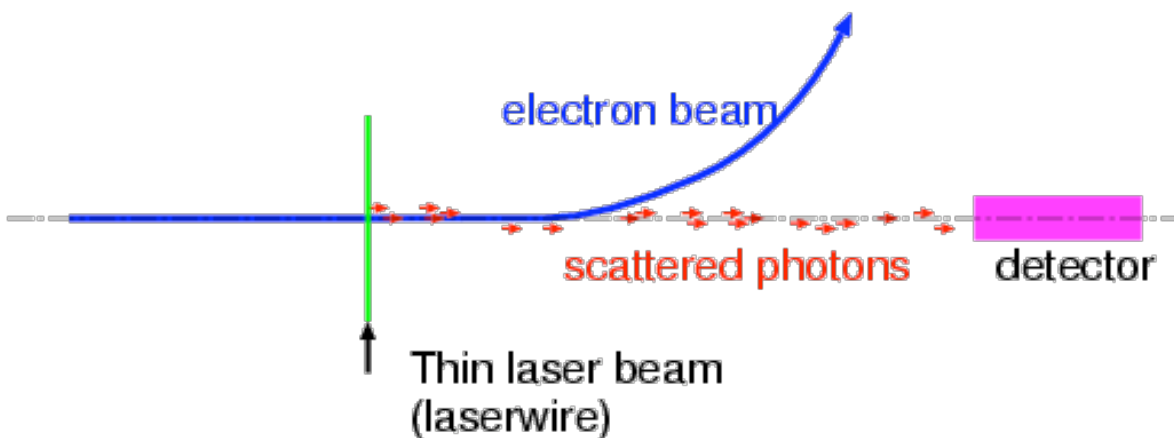
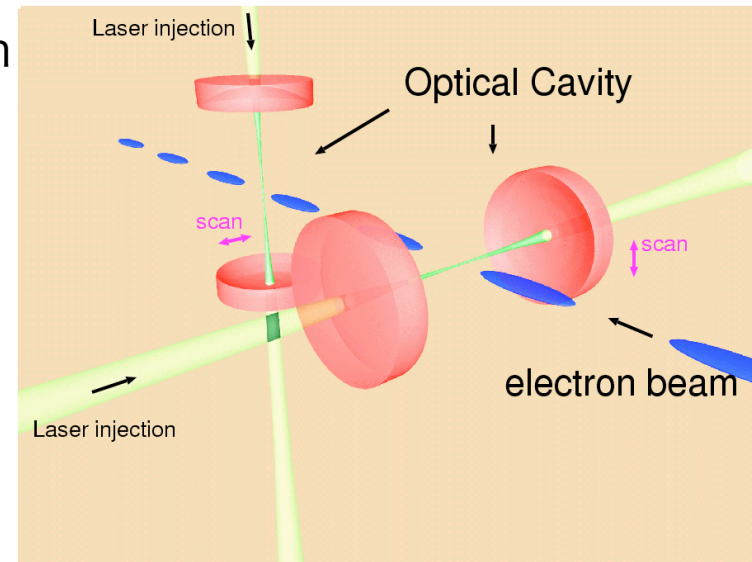

laser system

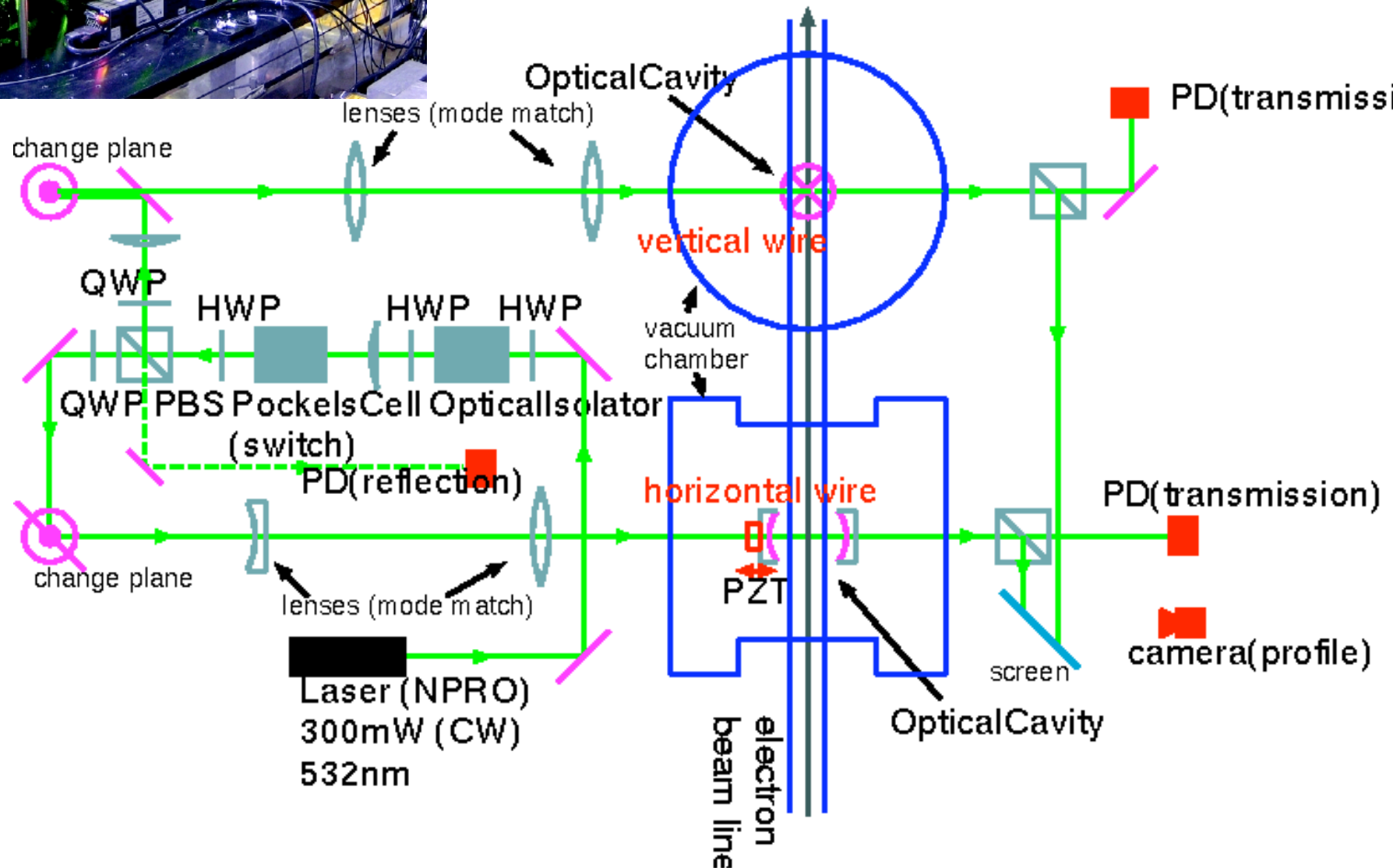
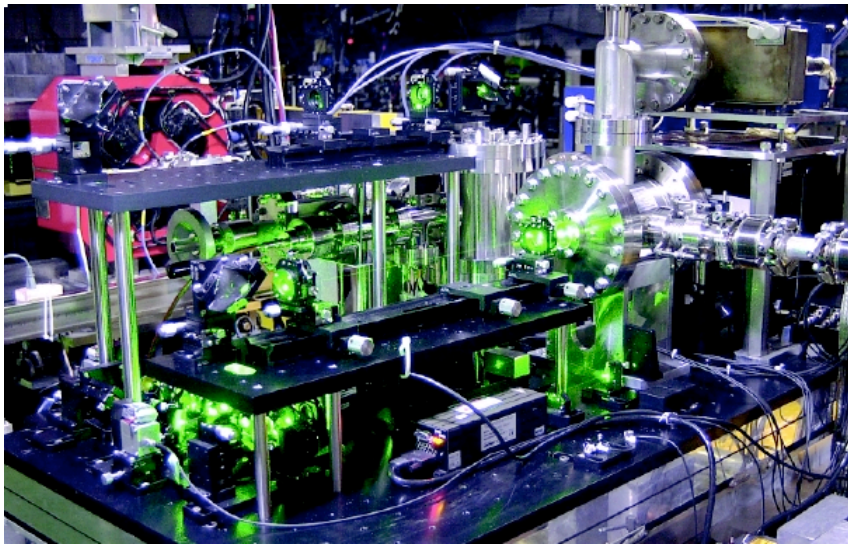

layout and e-beam condition

- electron beam to be measured
 - typically, $5\mu\text{m}$ (vertical), $100\mu\text{m}$ (horizontal)
 - single or multi-bunch(2.8nsec separation)
 - stored beam in an equilibrium state

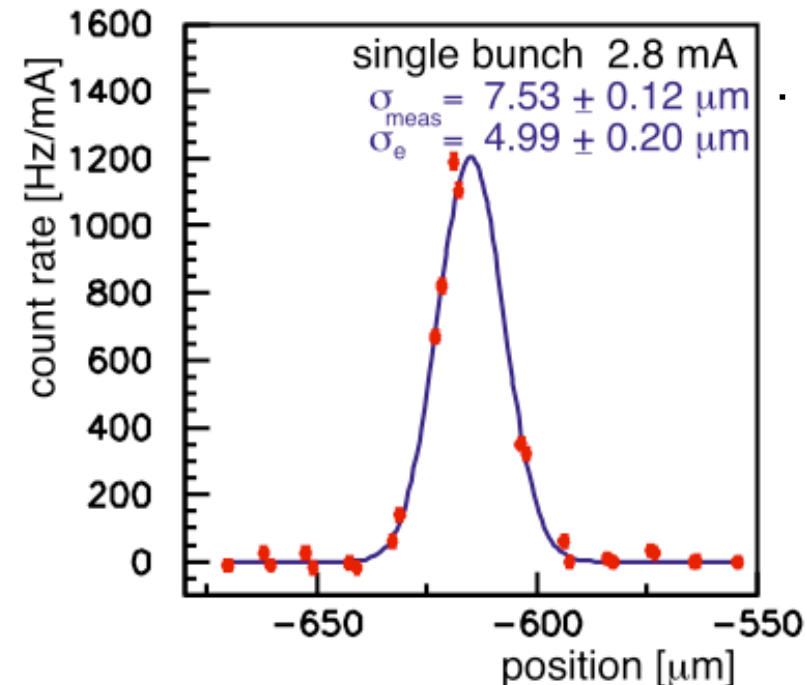
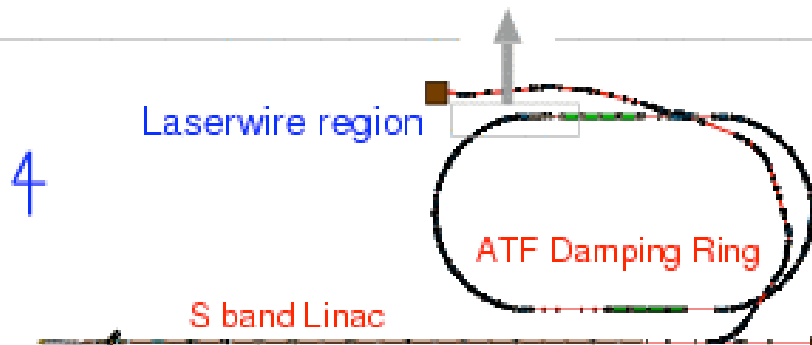
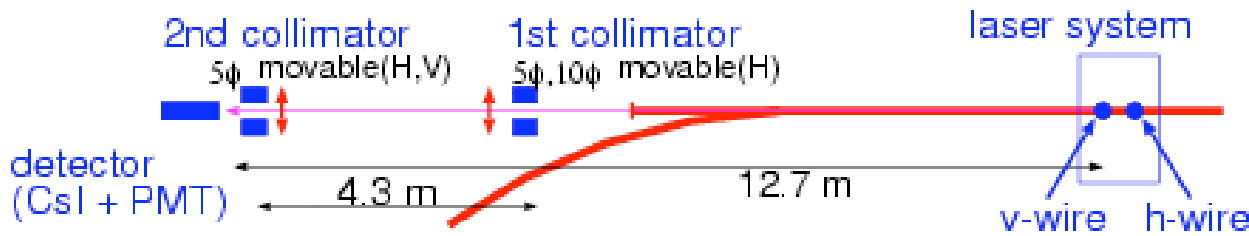
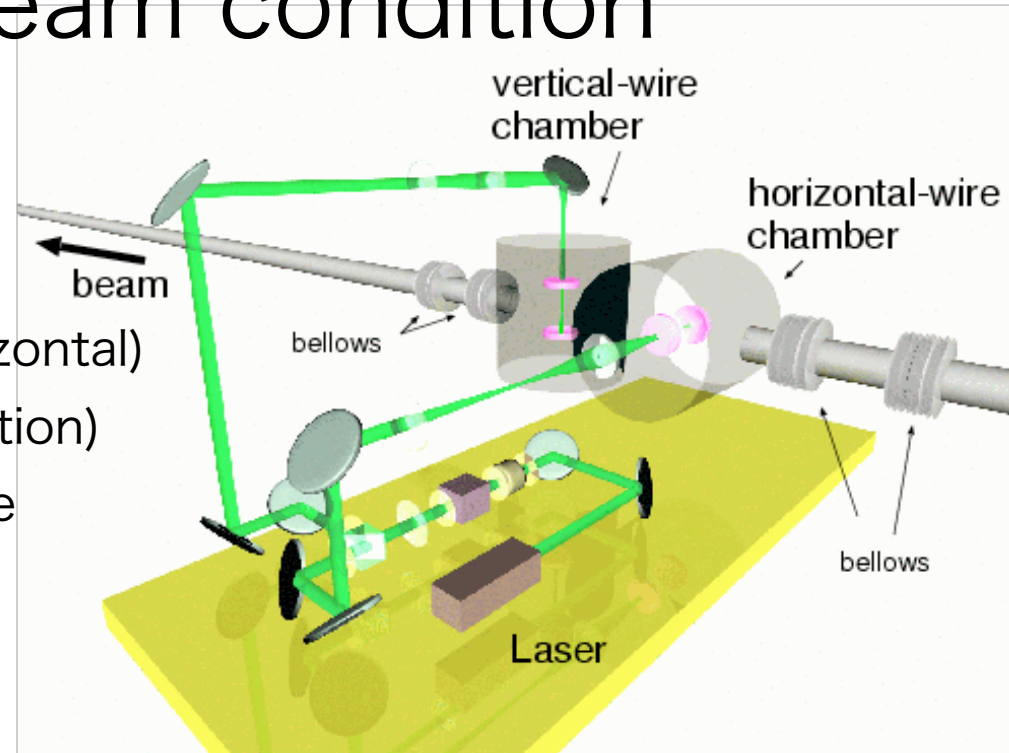

power enhancement

- resonance condition ($L = n\lambda / 2$)
- transmission power tells the status
- enhancement factor is proportional to
 - sharpness of the peak (finesse)
 - transmission of the coupler mirror

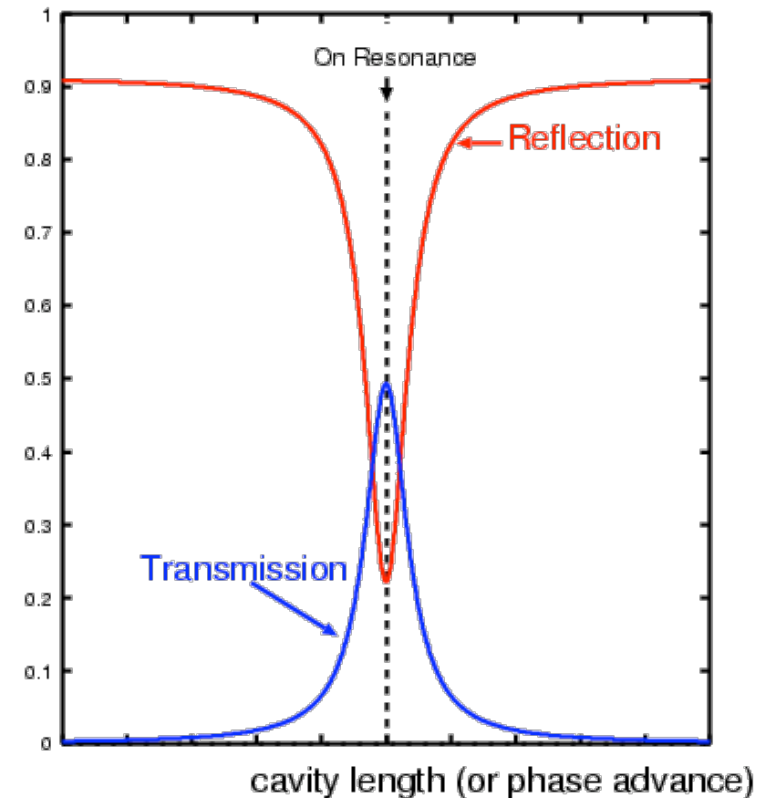
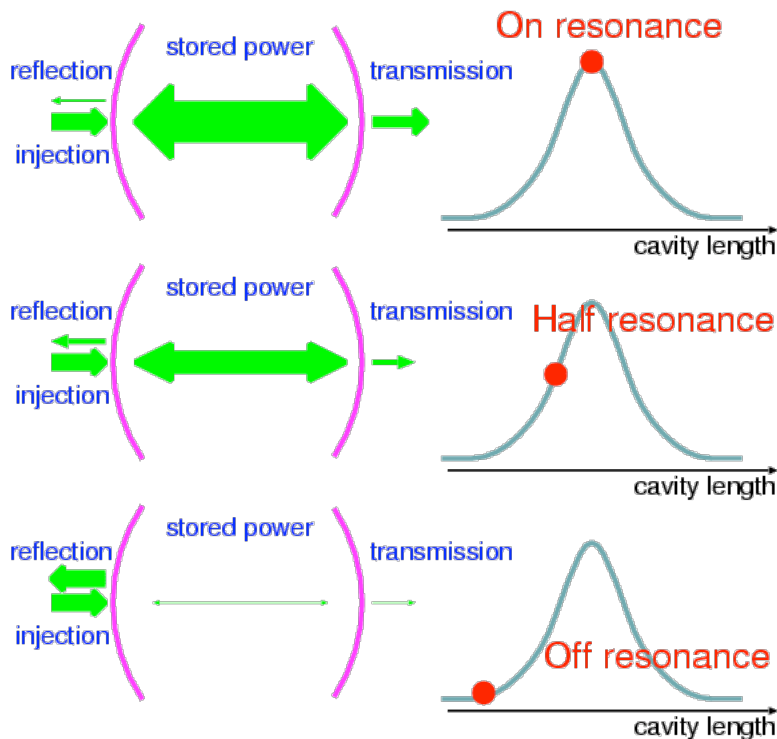
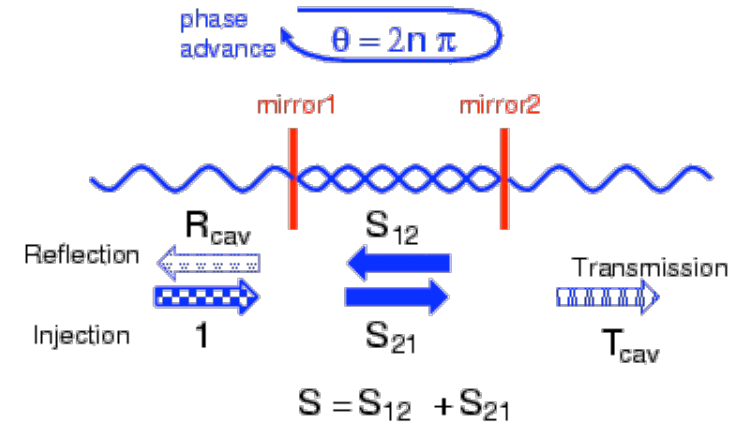

mechanical design

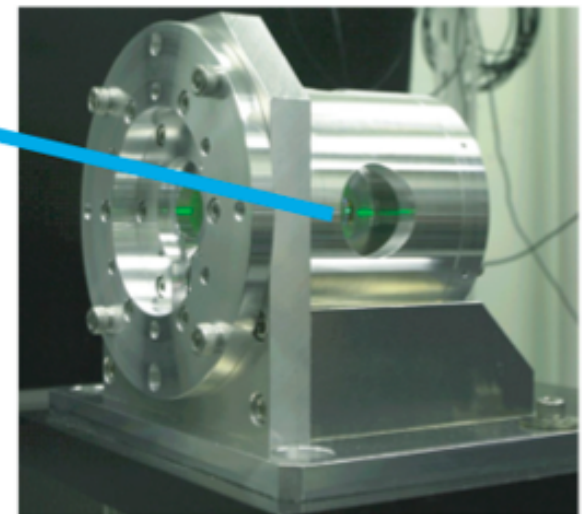
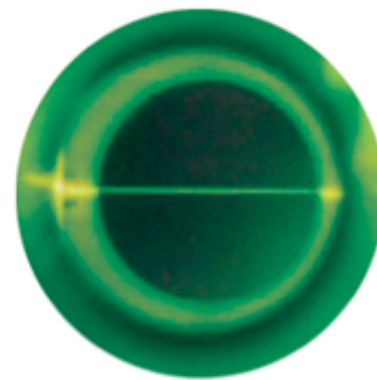
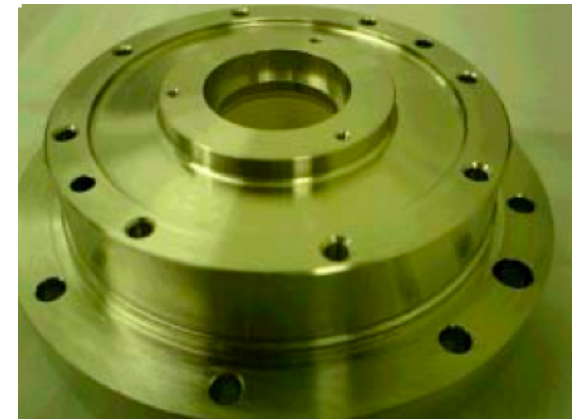
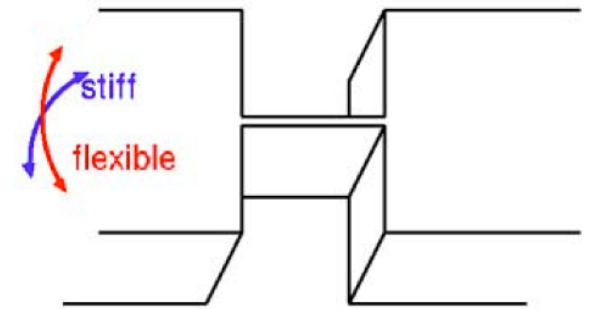
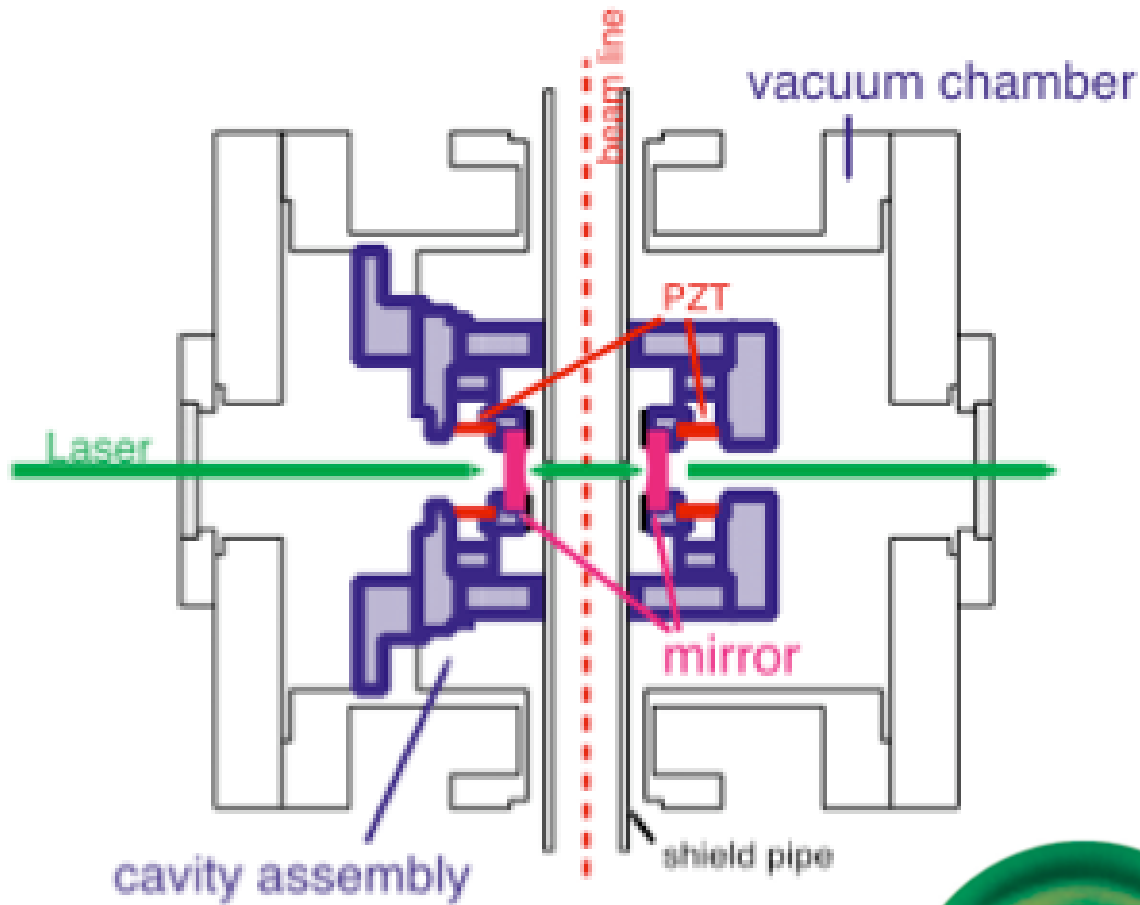

diffraction limited beam

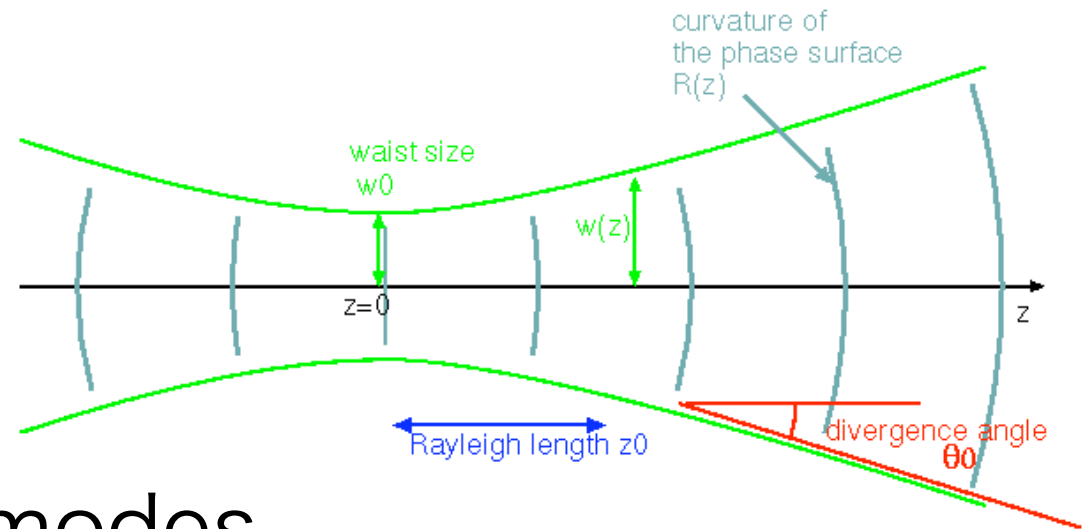

helmete gauss modes

$$E_{mn}(x, y, z) = A \frac{w_0}{w(z)} \exp\left(-\frac{x^2 + y^2}{w^2(z)}\right) H_m\left(\frac{\sqrt{2}x}{w_0}\right) H_n\left(\frac{\sqrt{2}y}{w_0}\right) \\ \times \exp\left(-ik \cdot \frac{x^2 + y^2}{2R(z)}\right) \exp(i\Phi(z)) \times \exp(i\omega t - ikz)$$

$$w(z) = w_0 \sqrt{1 + \left(\frac{z}{z_0}\right)^2}, \quad \text{lowest order (m=n=0) is the gaussian profile}$$

$$R(z) = z \left\{ 1 + \left(\frac{z_0}{z}\right)^2 \right\}, \quad \text{additional phase (guoy phase } \Phi) \text{ in higher order modes}$$

$$\Phi(z) = (m + n + 1) \arctan\left(\frac{z}{z_0}\right),$$

$$z_0 = \frac{\pi w_0^2}{\lambda},$$

laser beam stored in a cavity

- boundary condition by the mirrors
 - L, ρ define beam waist (and λ)
- if $L > 2\rho$, no solution (unstable resonator)

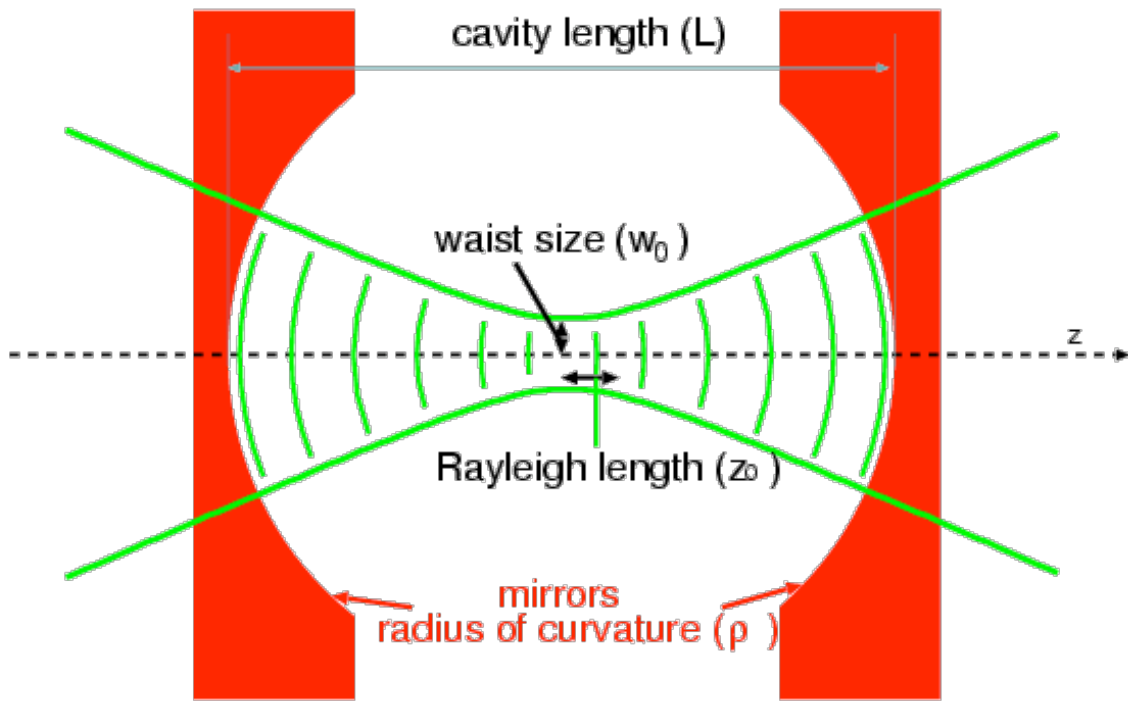

$$w_0^2 = \frac{\lambda}{\pi} \frac{\sqrt{L(2\rho - L)}}{2}$$

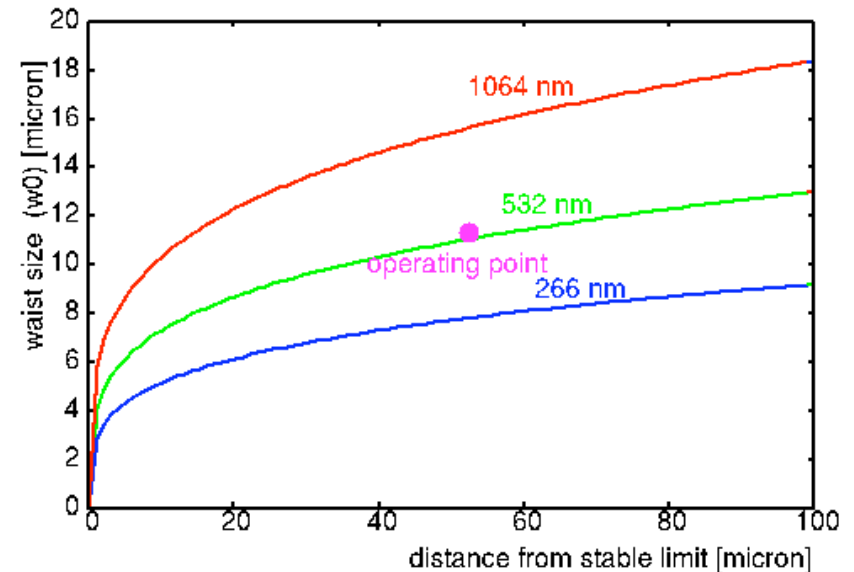
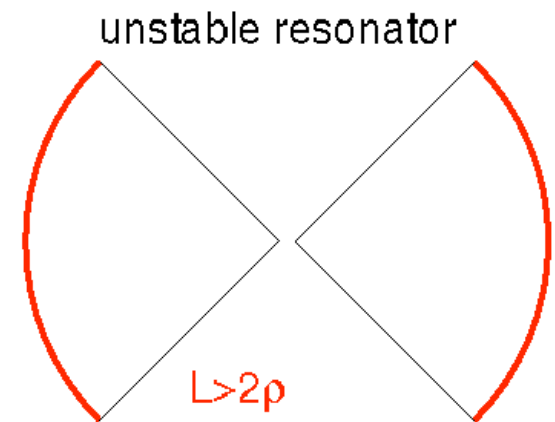
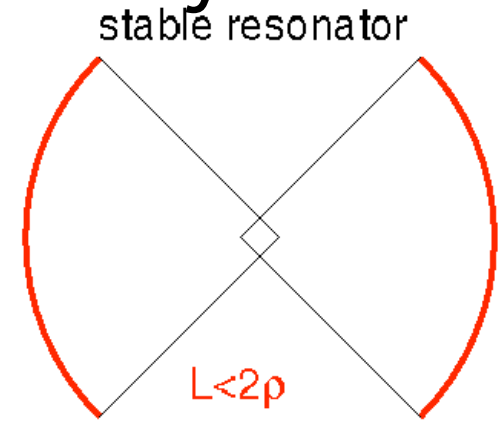

transverse modes

- $m, n > 0$
- additional phase factor
 - resonance condition shifts
 - amount of the shift is related to w_0

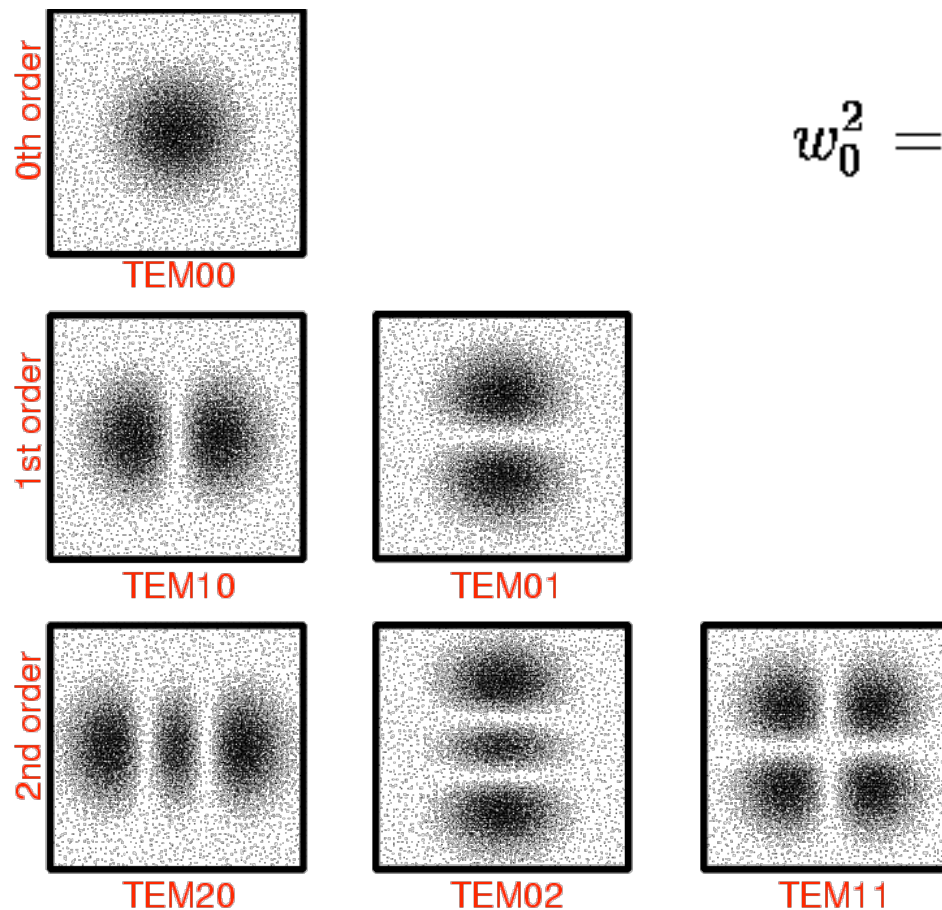
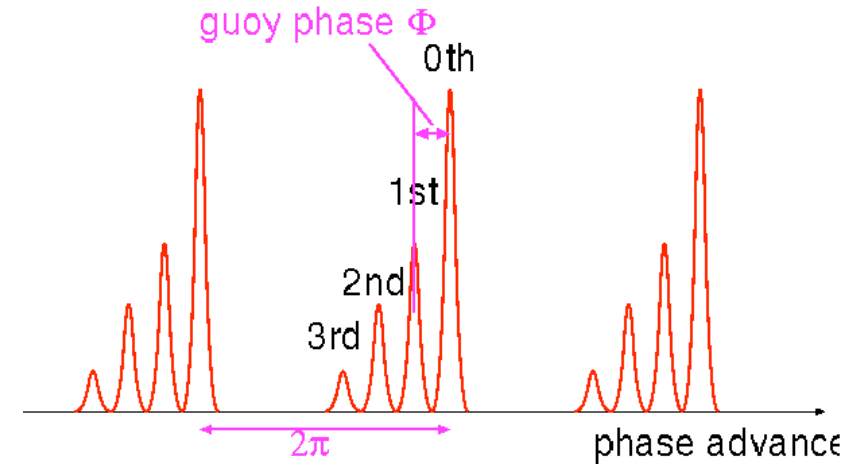

$$w_0^2 = \frac{\lambda L}{2\pi} \sqrt{\frac{1 - \cos(\Delta\Phi)}{1 + \cos(\Delta\Phi)}}$$

optics tuning

- sweep the cavity length using PZT
- observe excitation modes through cavity transmission
-

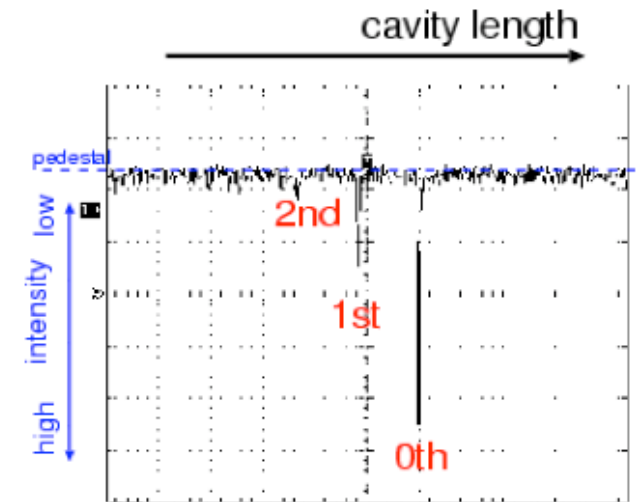
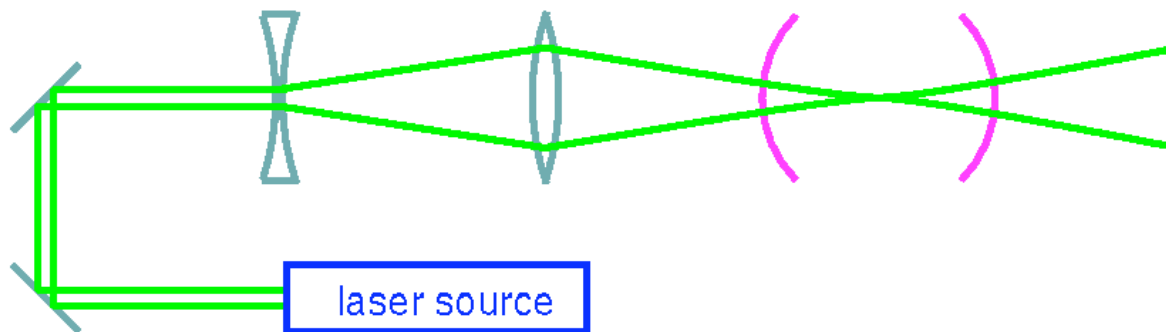

(a) before matching
cavity length

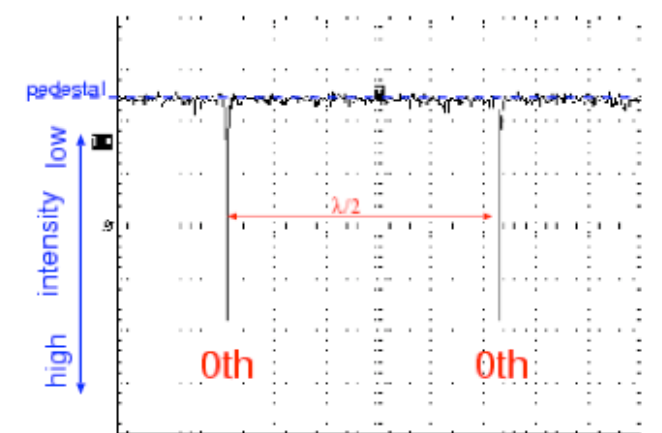

(b) after matching

measurement of laser waist

$$\theta_0 \equiv w(z)/z \approx \frac{\lambda}{\pi w_0}$$

- Three methods
 - divergence of cavity transmission
 - phase difference in transverse modes
 - waist scan with electron beam
- result
- $w_0 = 11.3 \pm 0.16 \mu\text{m}$, $z_0 = 760 \mu\text{m}$

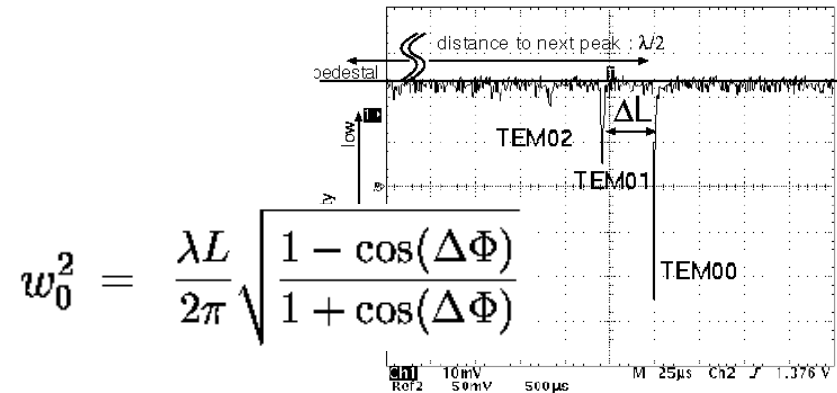

$$w_0^2 = \frac{\lambda L}{2\pi} \sqrt{\frac{1 - \cos(\Delta\Phi)}{1 + \cos(\Delta\Phi)}}$$

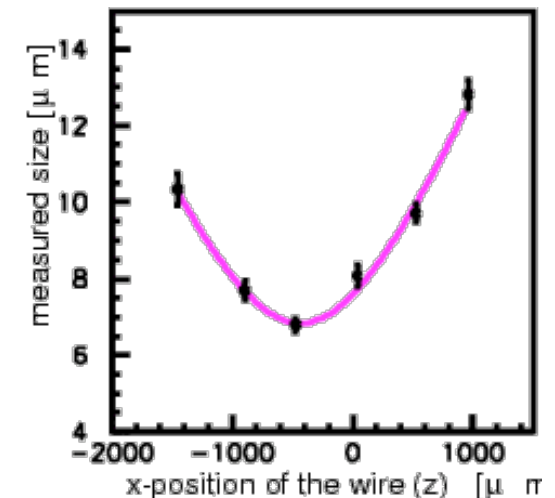
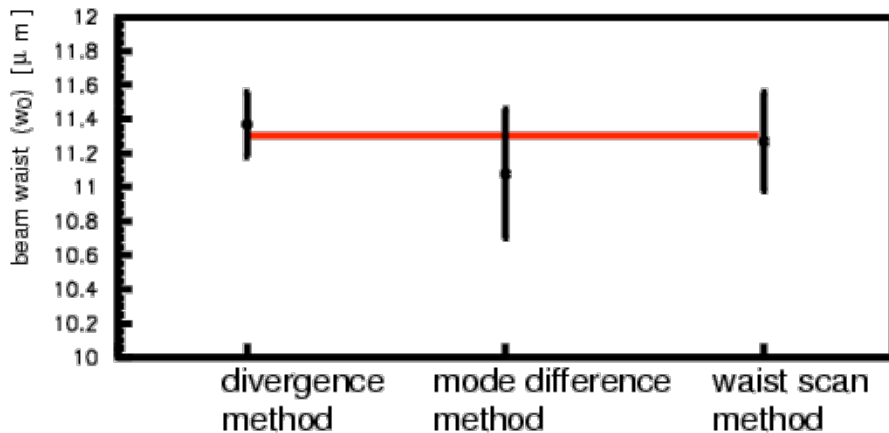
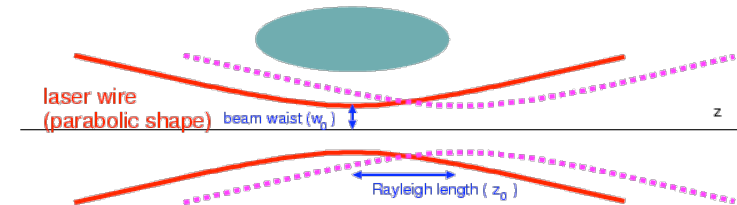

Compton signal detection

- Max. energy 29MeV
- detector
 - CsI(pure): 70mm×70mm×300mm
 - leading edge: 0.56nsec
 - counting
- background
 - spent electron via intra-beam scattering
 - reduce detector aperture

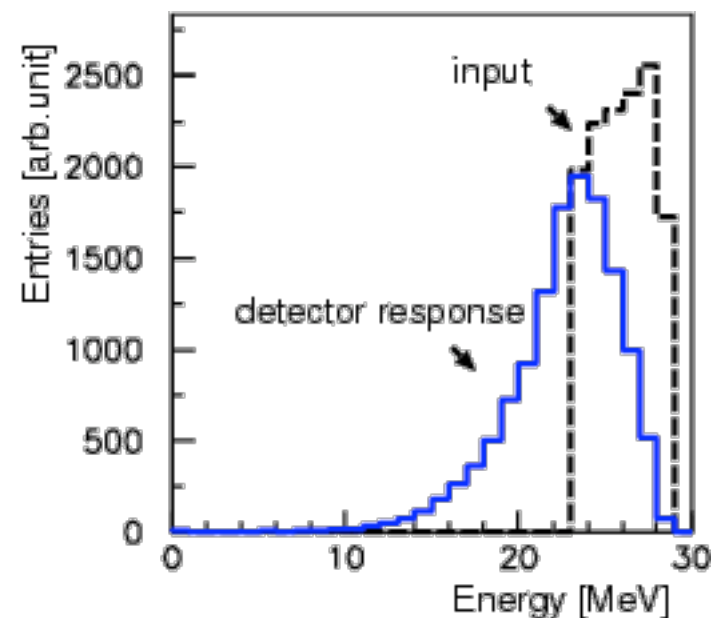
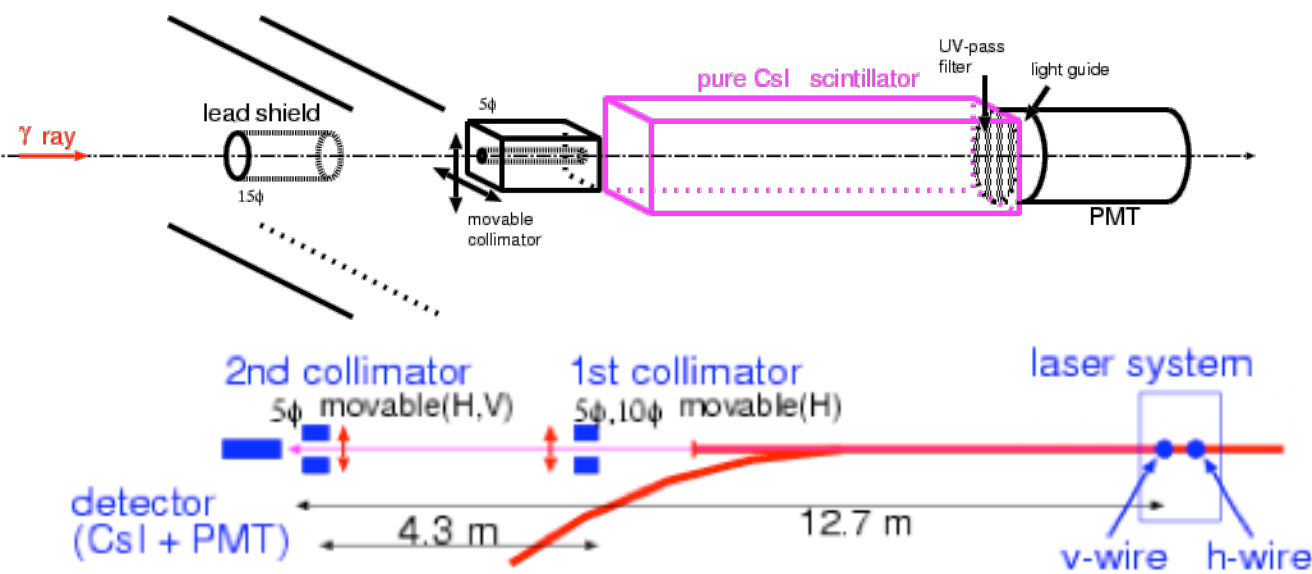
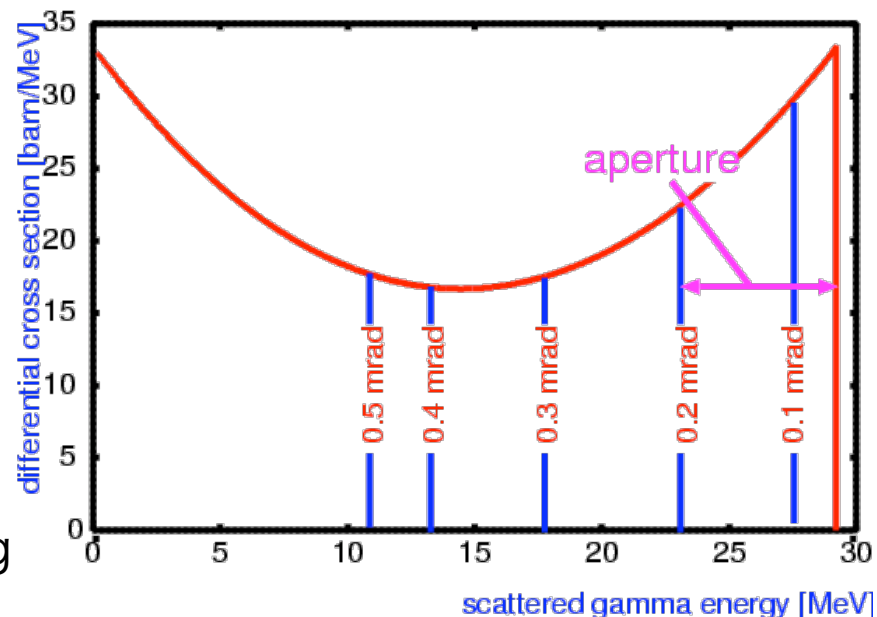

optical cavity control

- simultaneous b.g. measurement
 - on/off resonance

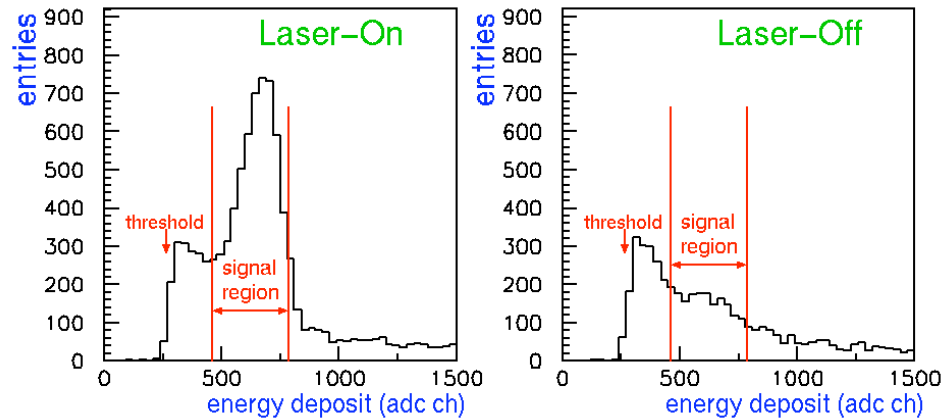

cavity transmission
low ↑
high ↓

veto for laser off scaler
veto for laser on scaler

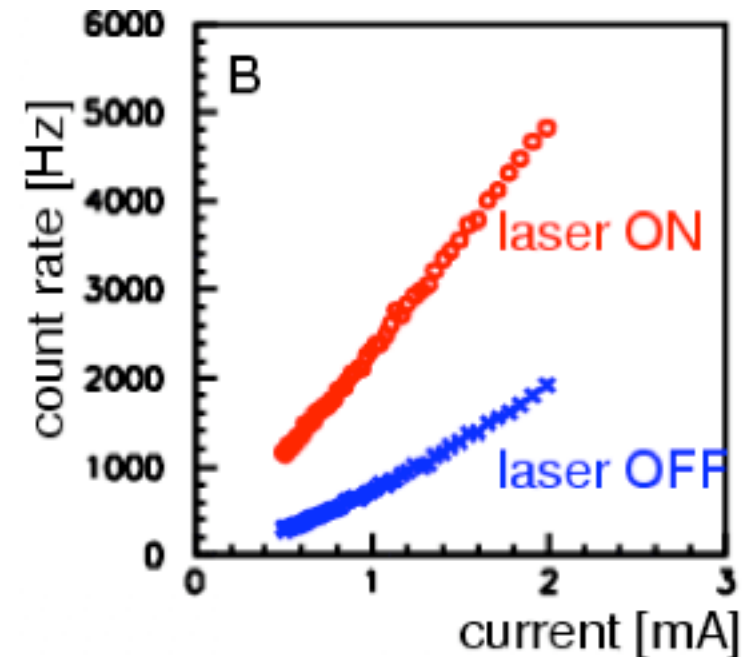
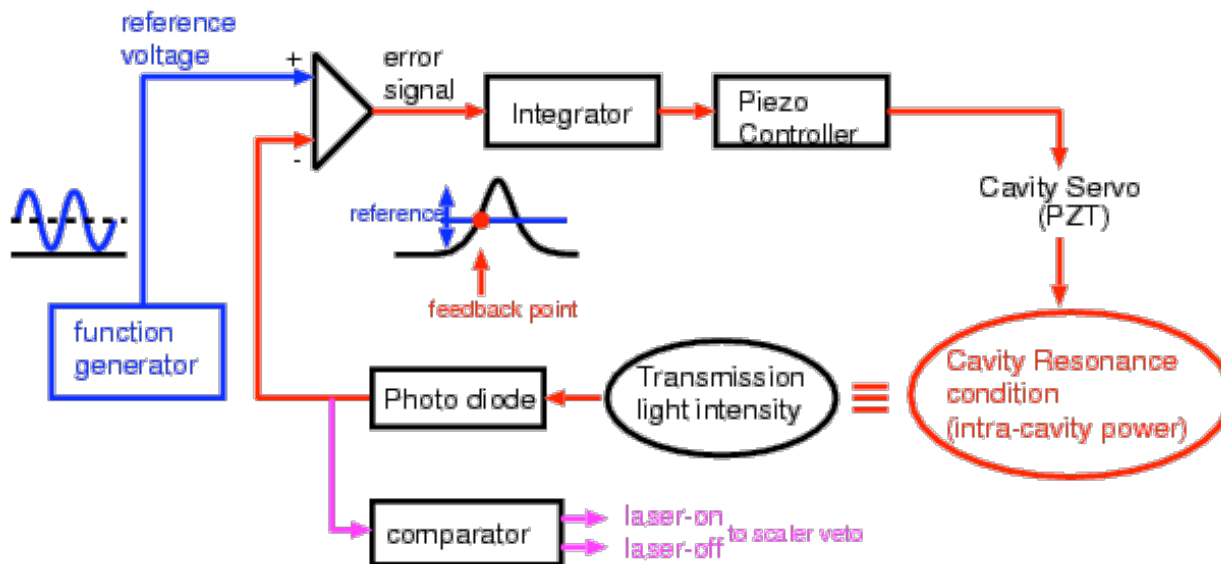
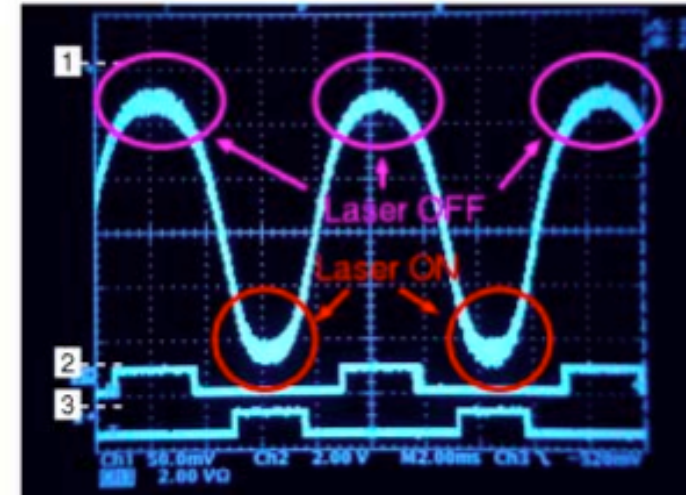

measurement example

- procedure
 - storage beam in DR
 - $10\mu\text{m}$ step, 10sec/position
 - re-fill DR

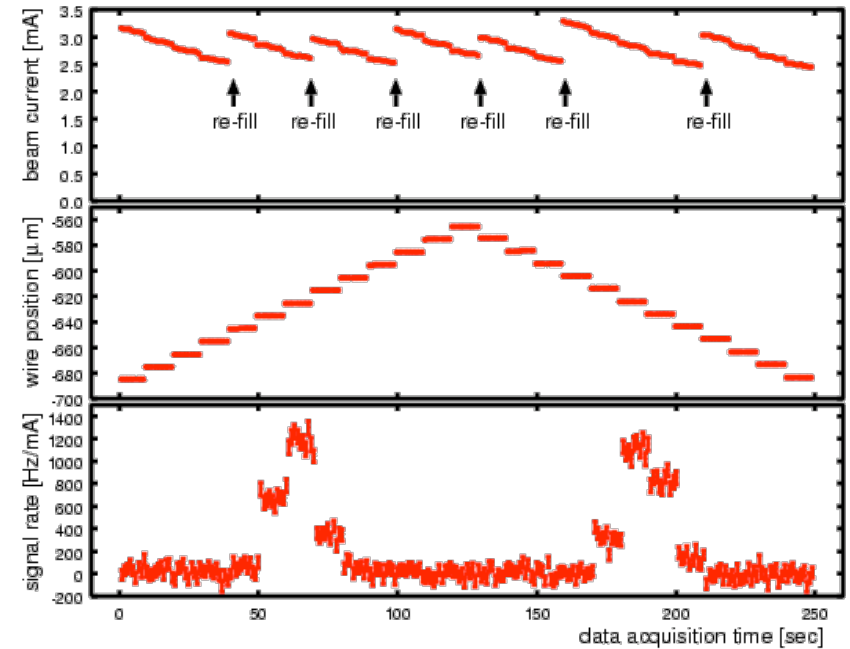

$$\sigma_e = \sqrt{\sigma_{meas}^2 - \sigma_{lw}^2}$$

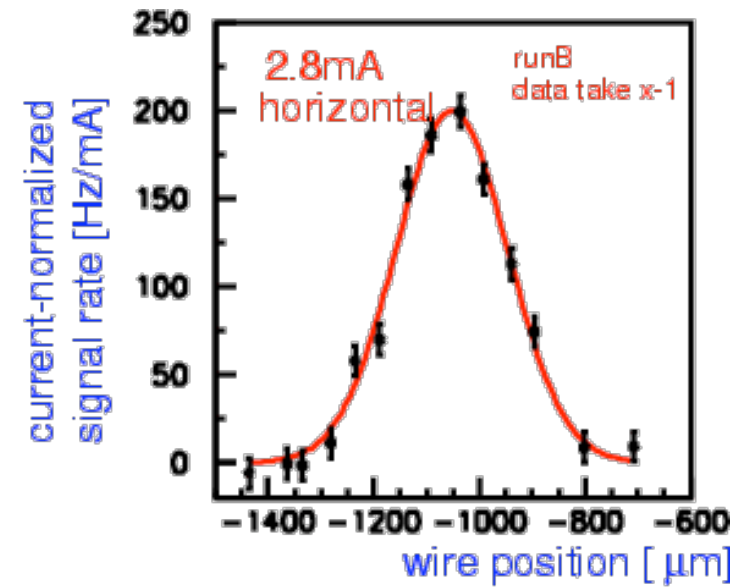
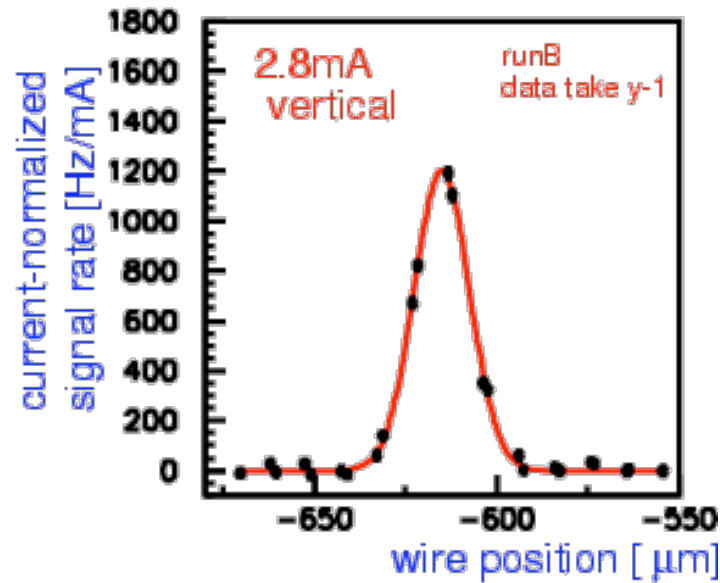

multi-bunch example

- 20 bunch, 2.8 nsec spacing
- detect timing of each event

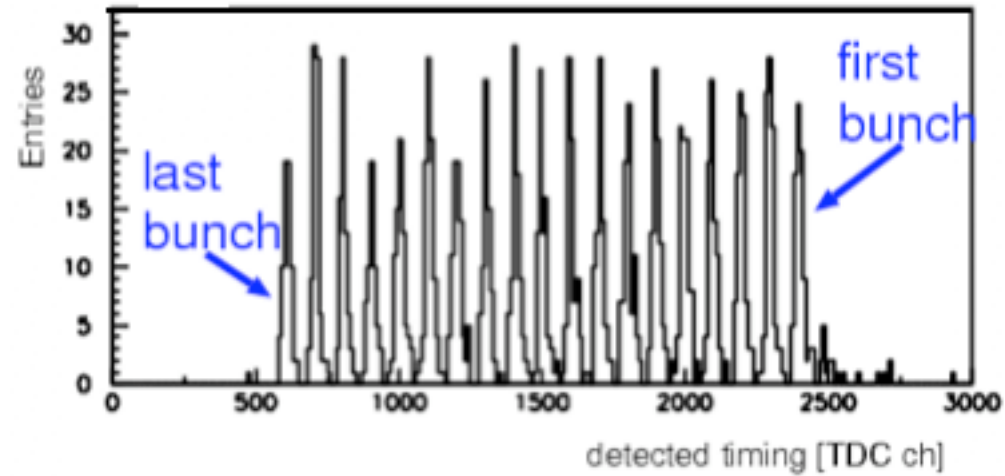

Measurement in 2004

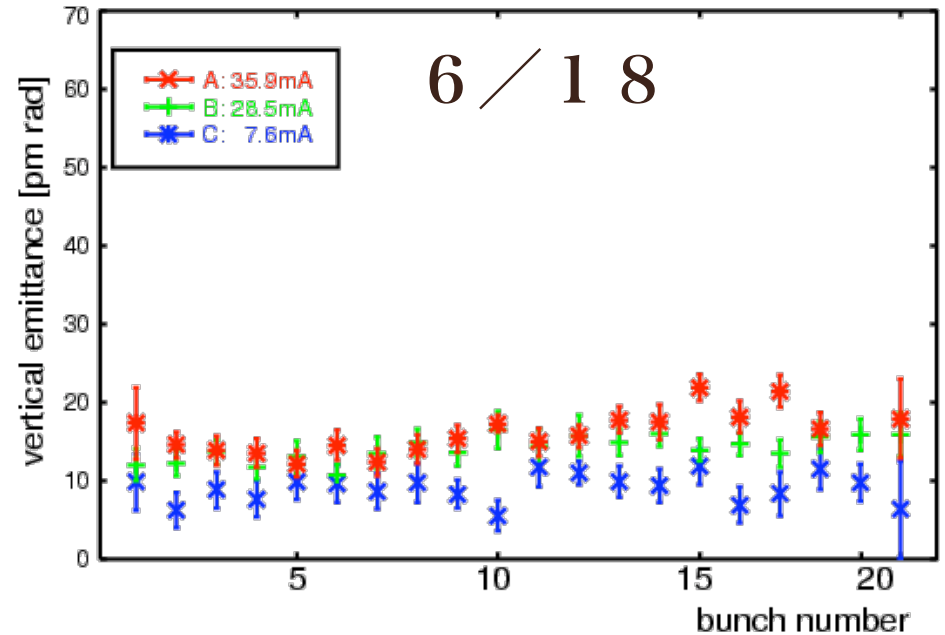
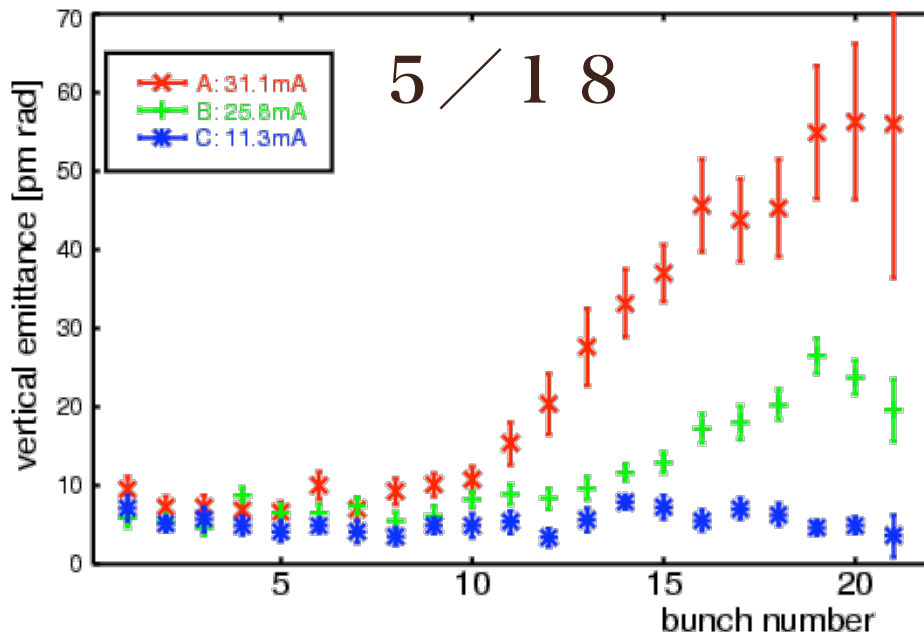

emittance damping

- measure beam size at different timing after injection

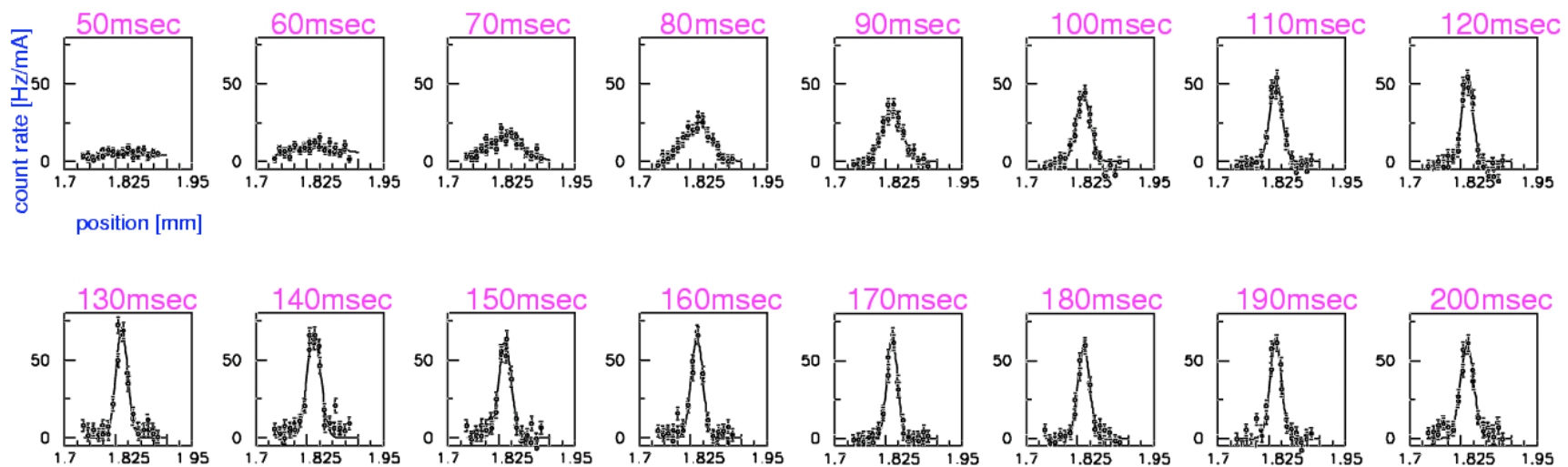
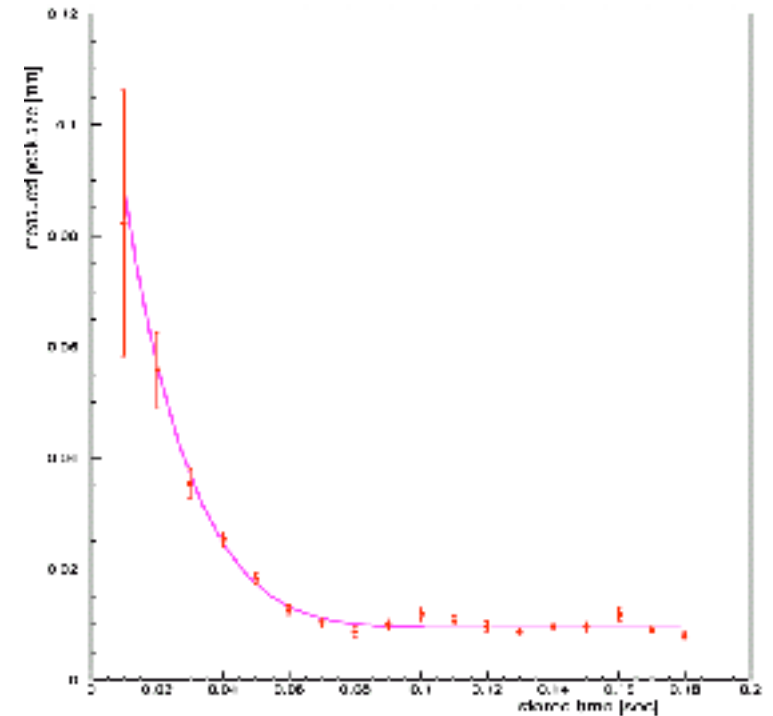

HOM

- smaller structure in higher transverse modes
- selective excitation of TEM01 mode
 - degeneration with TEM10
 - excitation efficiency

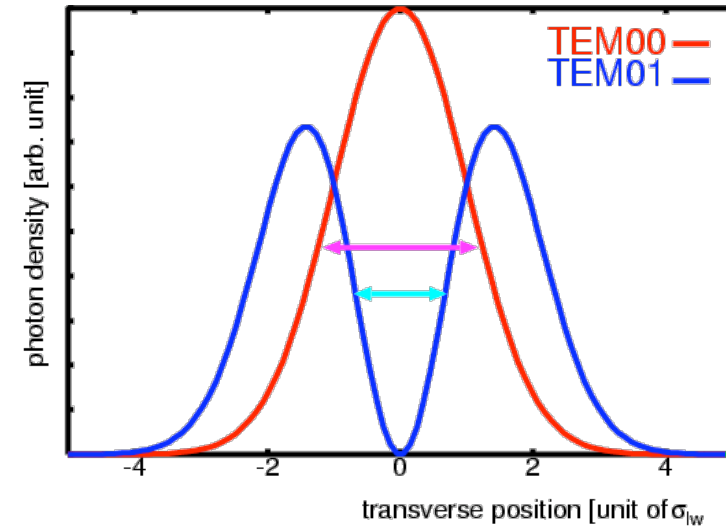

$$P(\text{photon}) \sim \exp\left(-\frac{y^2}{2\sigma_{lw}^2}\right)$$

$$P(\text{photon}) \sim y^2 \cdot \exp\left(-\frac{y^2}{2\sigma_{lw}^2}\right)$$

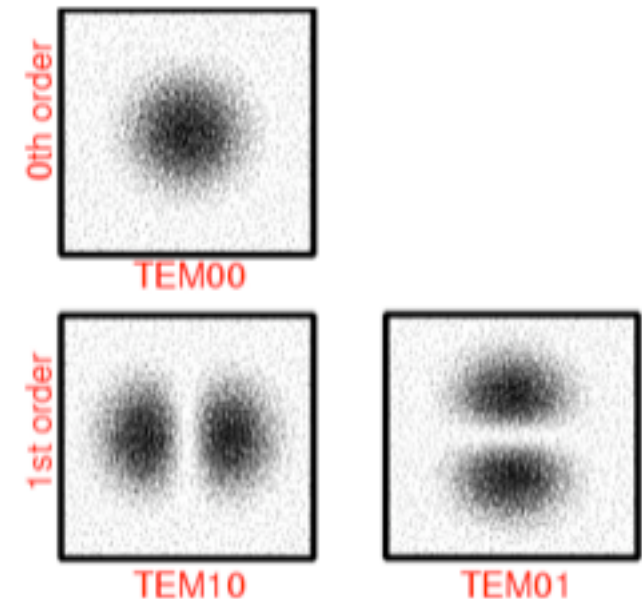
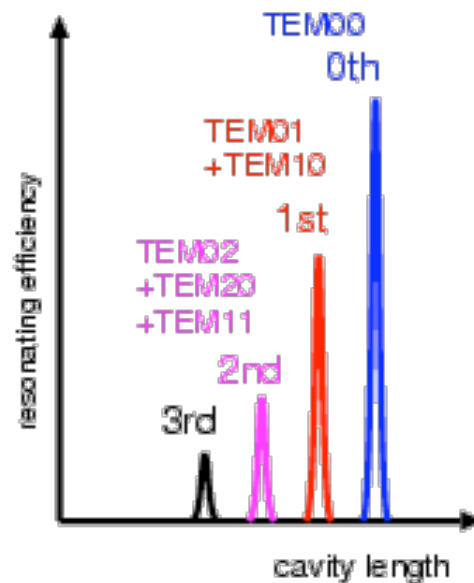

split TEM01 and TEM10

- bent mirror a little

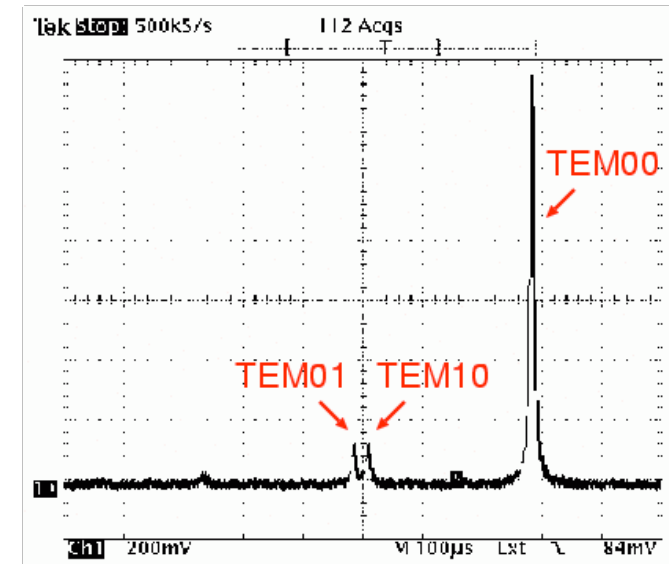
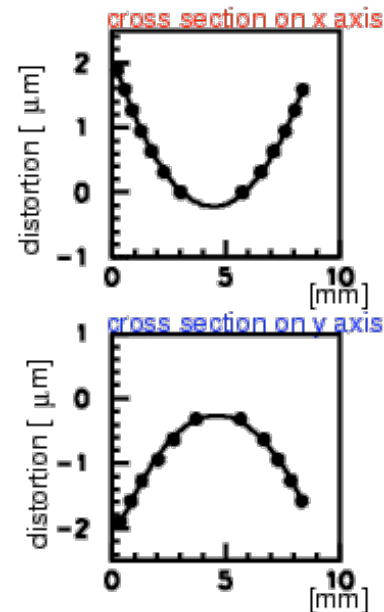
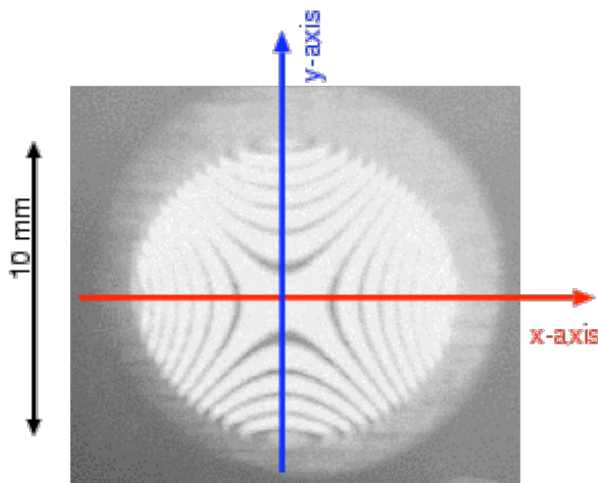
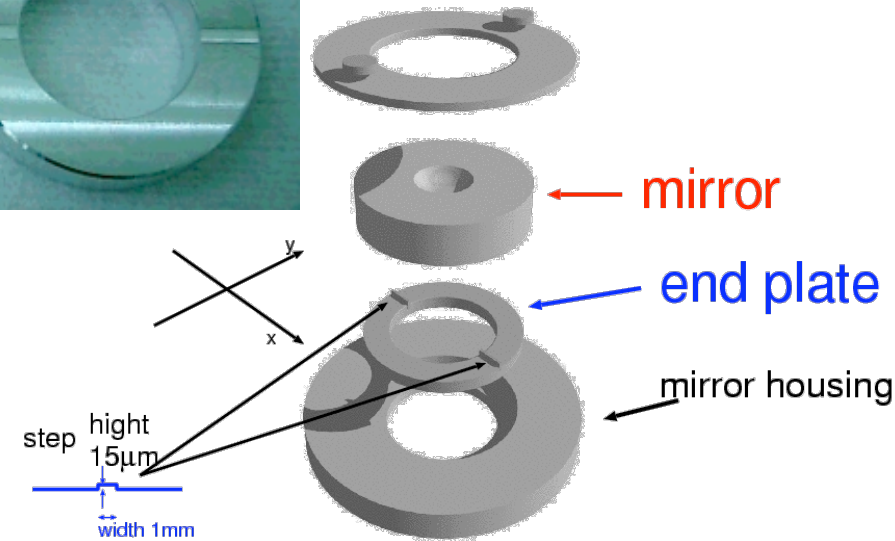
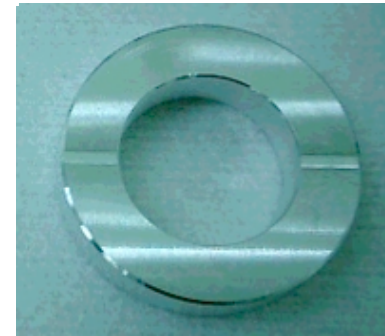

efficient excitation of TEM01

- Mode converter
 - flip phase to increase dipole component

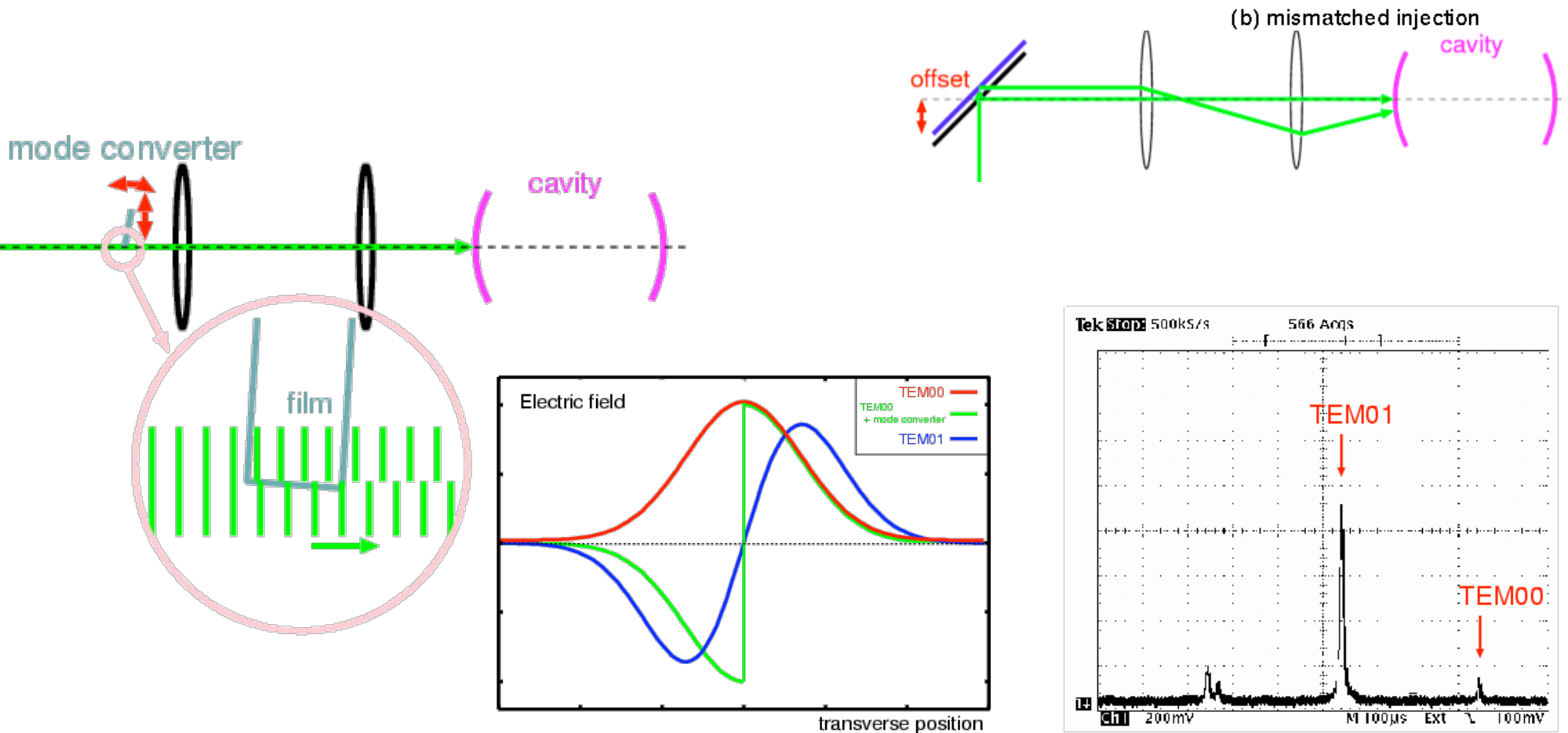
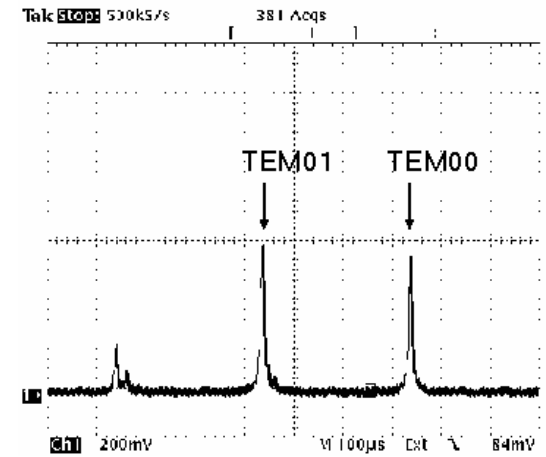

look with a micro scope

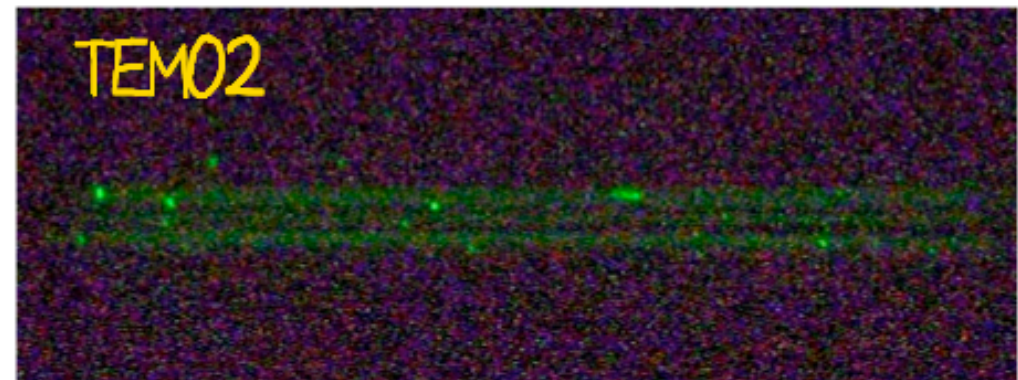
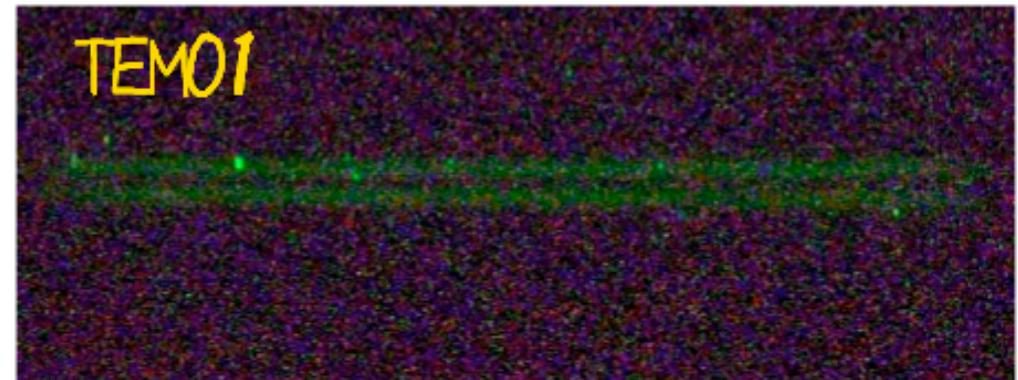
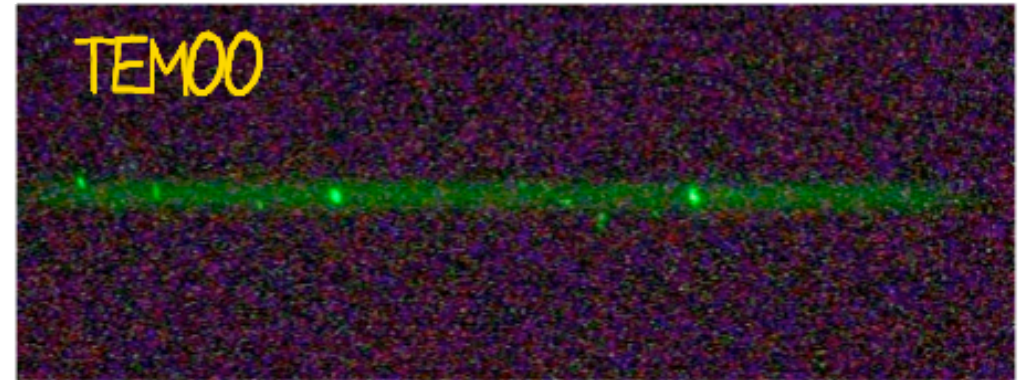
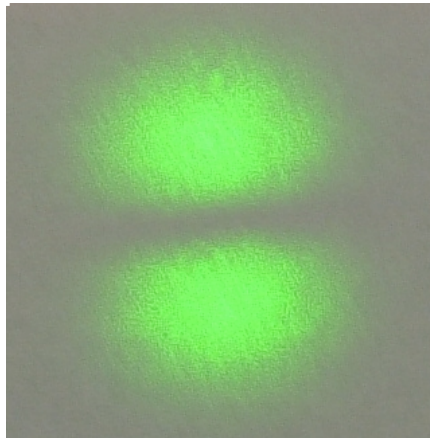

example of beam measurement

- fitting
 - both laser size, e-beam size are free parameters.

$$\left(\frac{\sigma_{lw}^2}{\sigma_e^2 + \sigma_{lw}^2} \cdot y^2 + \sigma_e^2 \right) \exp \left(-\frac{y^2}{2(\sigma_e^2 + \sigma_{lw}^2)} \right)$$

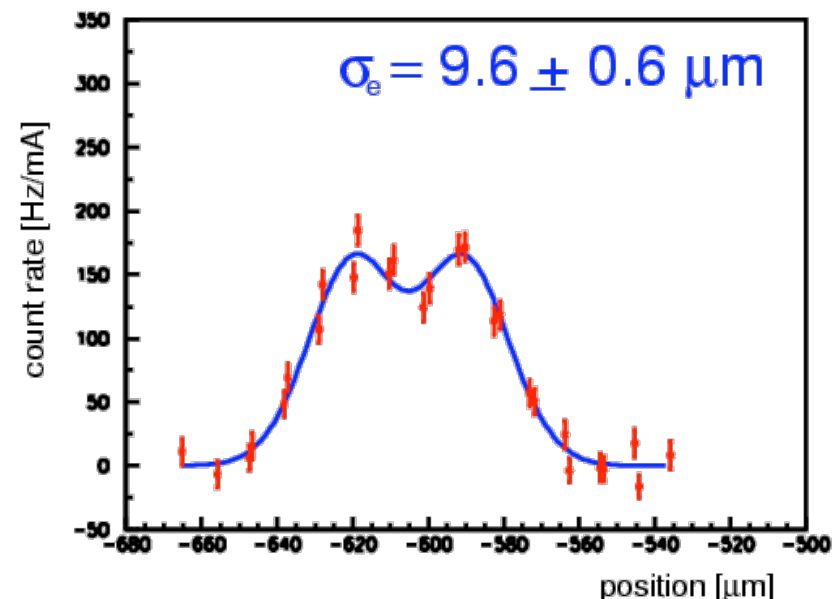
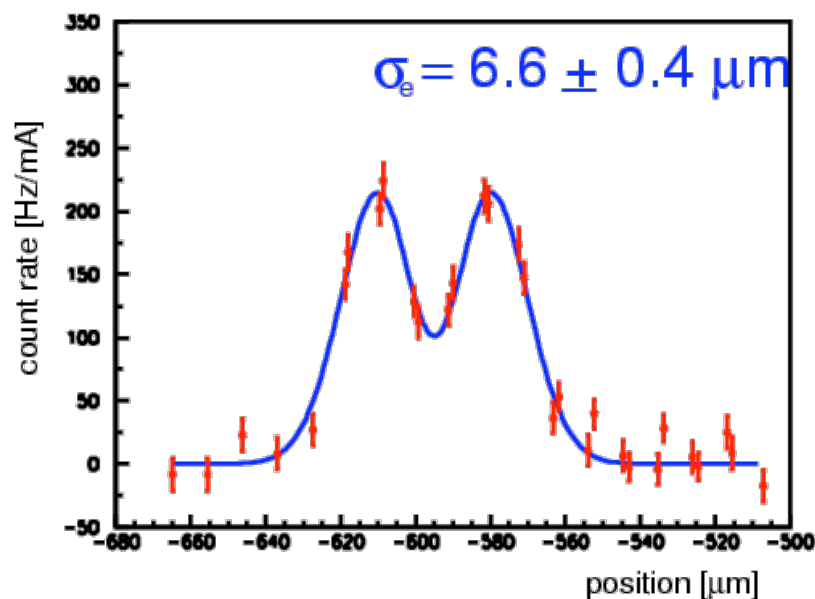
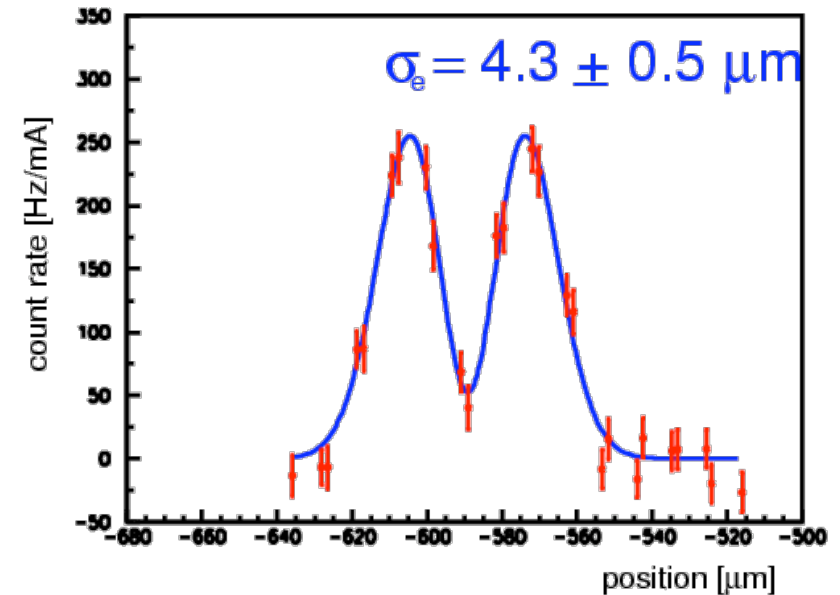

mode-lock laser case

- inside the cavity of mode lock laser
 - many longitudinal modes
 - phase relation of the modes makes a short laser pulse
- external cavity
 - also has many longitudinal modes
 - all laser modes are accepted if laser cavity length = external cavity length

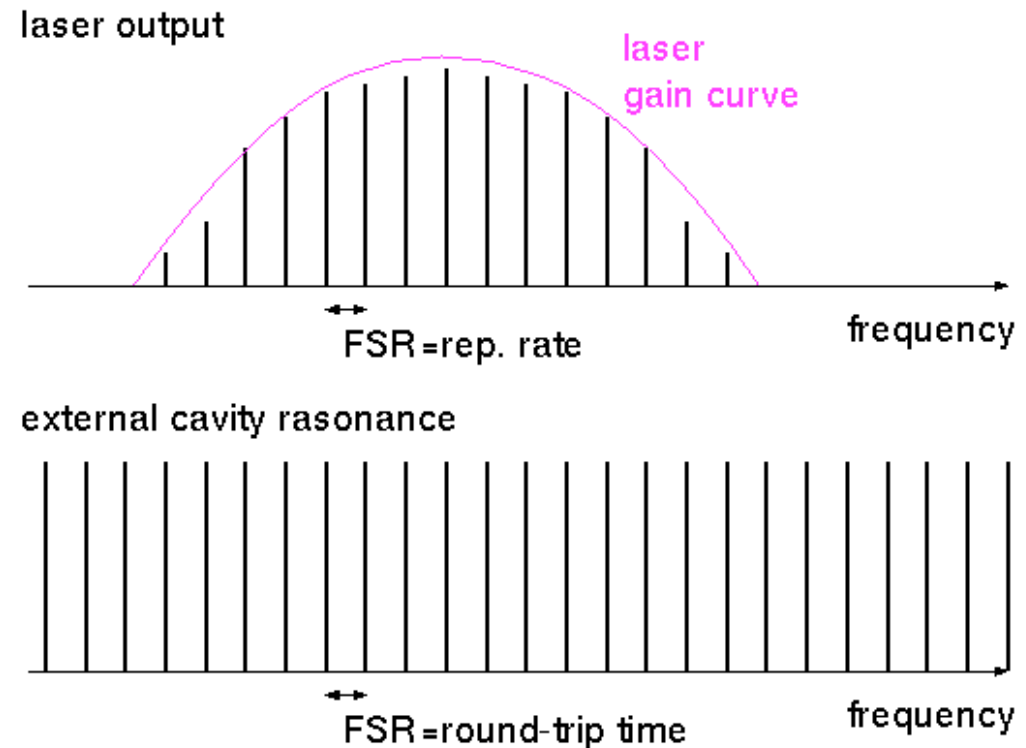
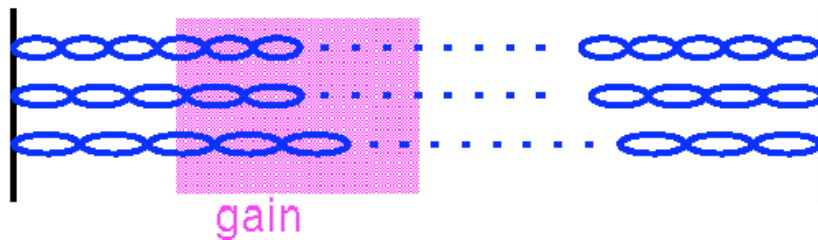

time domain

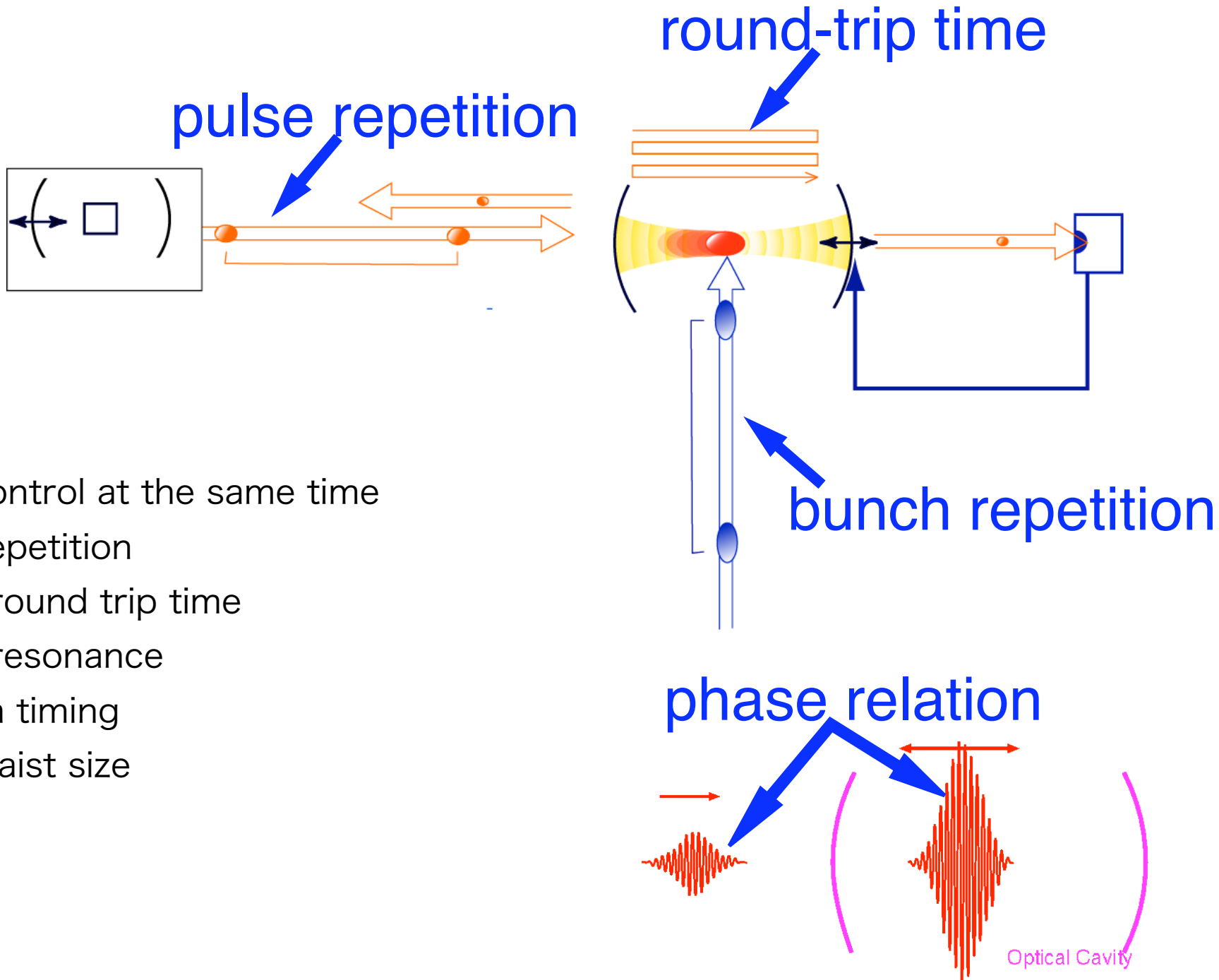

- need to control at the same time
 - laser repetition
 - cavity round trip time
 - cavity resonance
 - e-beam timing
 - laser waist size

1st model for pulsed laserwire

- cavity length=21cm (714MHz), two folded 357MHz cavity
- 1064nm, passive mode-lock(SESAM)

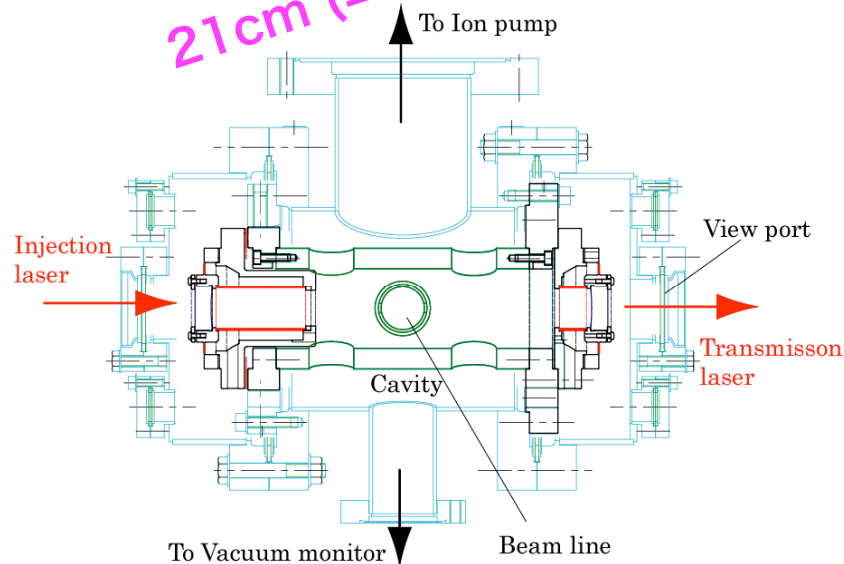
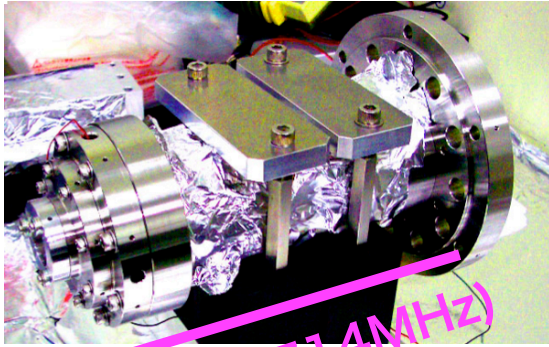

Beam	
repetition	357 MHz (2.8 ns)
bunch length	25 ps (rms)
Laser	
pulse repetition	357 MHz
pulse length	7.3 ps (FWHM)
power	500 mW
wave length	1064 nm
Cavity	
mirror reflectance	99.7 %
mirror curvature	250 mm
cavity length	21 cm
round-trip time	714 MHz
finesse	497
power enhancement	166
w0	250 micron

cavity setup

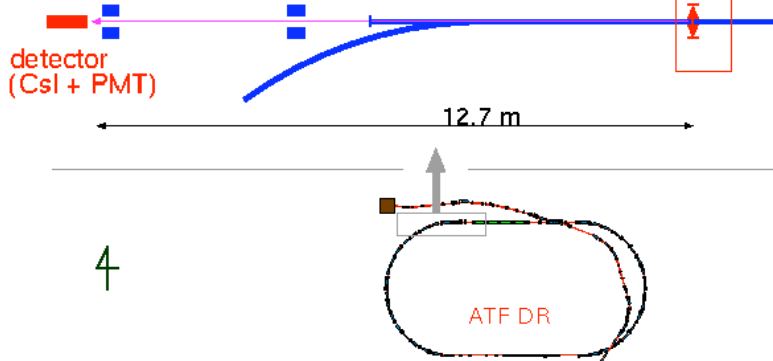
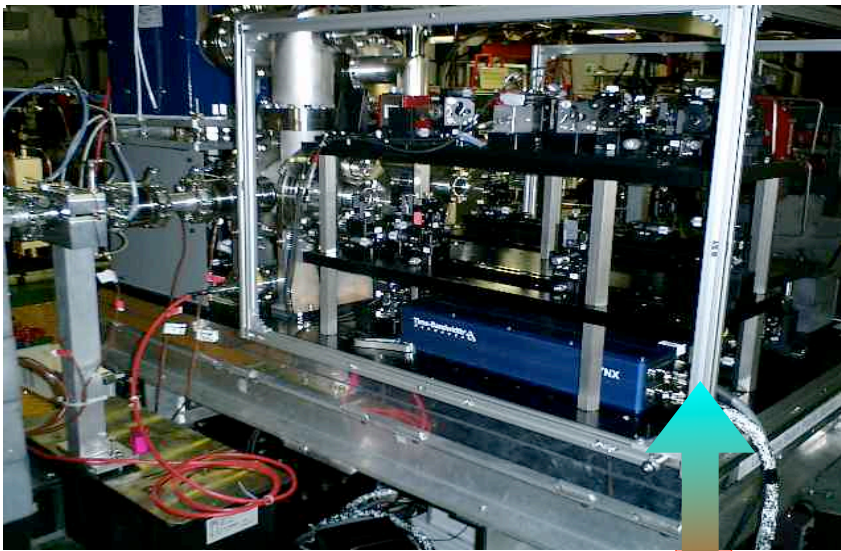

Cavity reflection

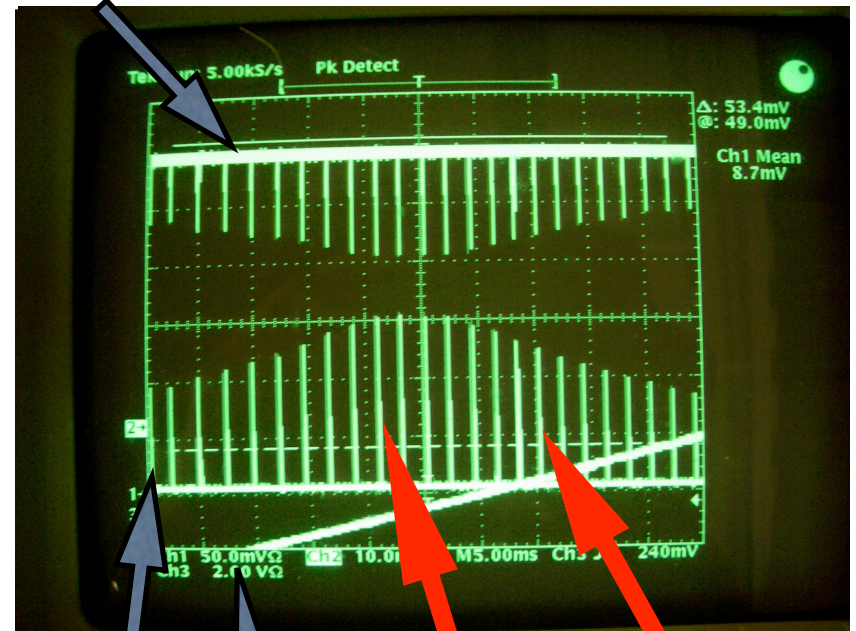

Cavity transmission

PZT HV
(cavity length)

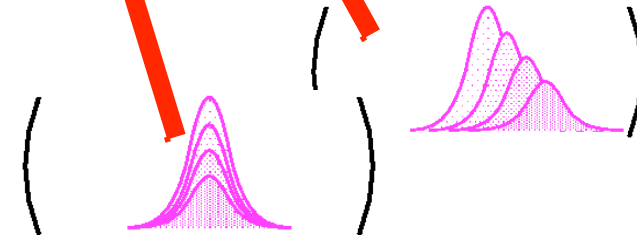

timing system

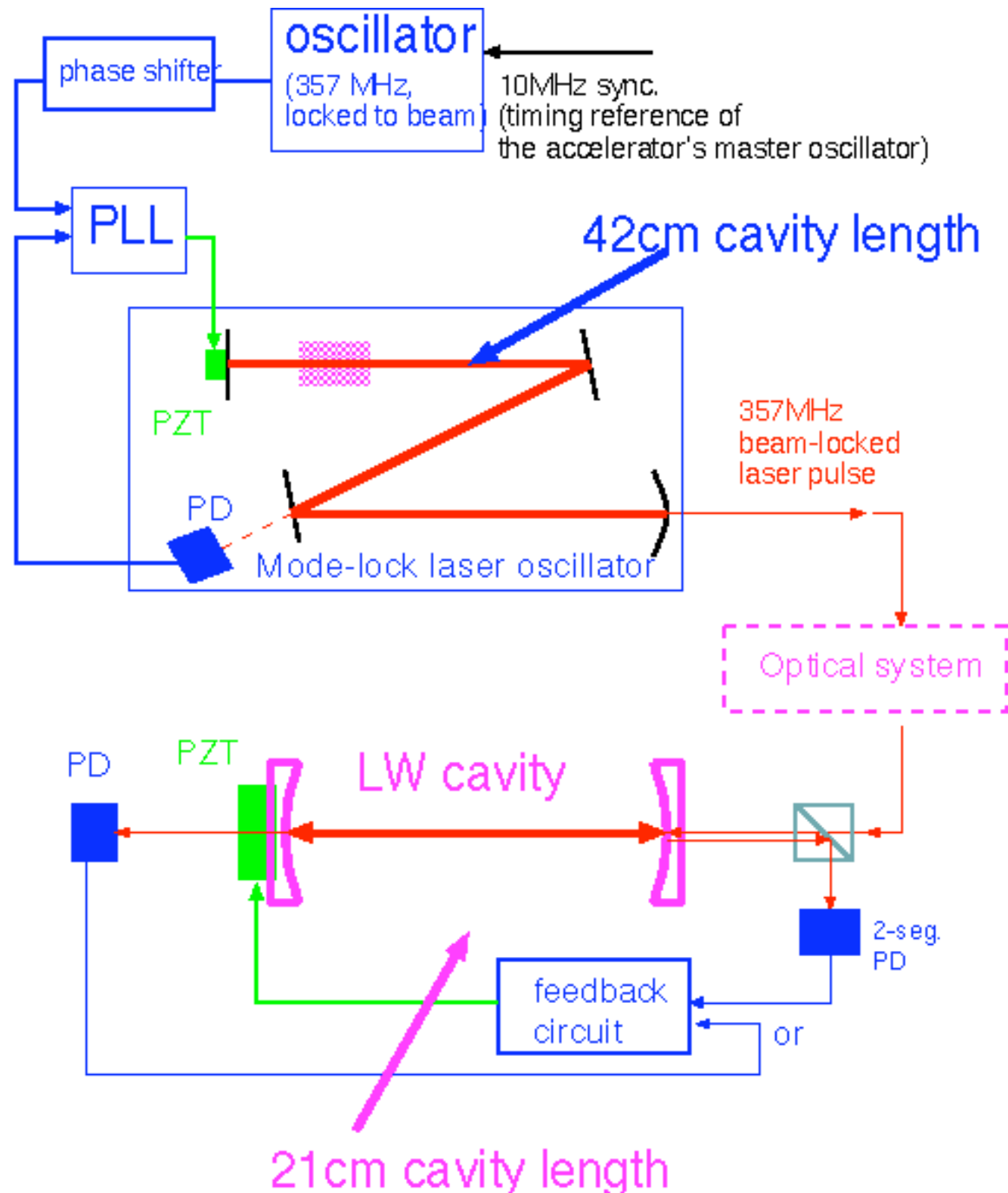

beam measurement

