

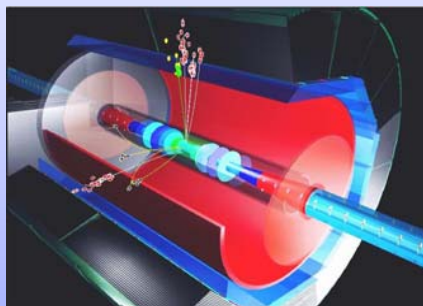

JRA1 Magnet and Test Beam Infrastructure

Tobias Haas
DESY



- Superconducting Magnet (PCMAG)
- Mechanics
- Cooling
- Telescope Simulations
- Measuring Mimostar2 @ DESY

EUDET Annual Meeting
19 October 2006



Preparation of Test Beam Area 24/1 for PCMAG



Entrance of Test Beam Area 24/1



- The test beam area is rearranged and renovated by MEA (Norbert Meyners).

Concrete Block as Base for PCMAG



- A concrete block is placed in the area as base for the PCMAG.
- Two holes with \varnothing 100mm are drilled in the floor, to access the cable trays in the cave, which connected the test beam area 24/1 with the control hut.
- The helium return line is installed.



Reminder: What PCMAG was designed for!



PCMAG



Recommissioning @ KEK

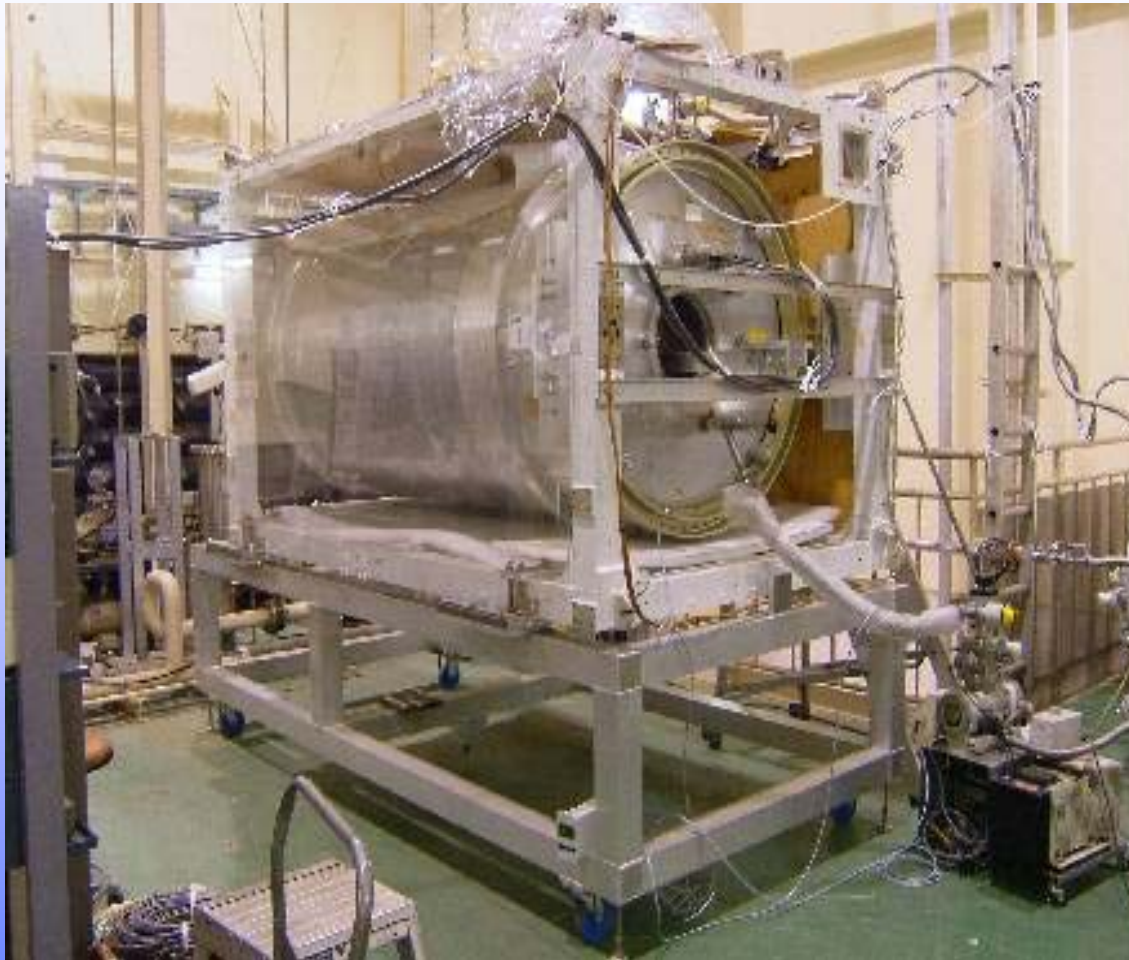

- All administrative issues about the transfer to DESY are clarified.
- Magnet arrives @ DESY in November
- Commissioning to take place @ DESY in November

Y. Makida, T. Matsuda/KEK, K. Ikematsu/DESY



DUT Positioner

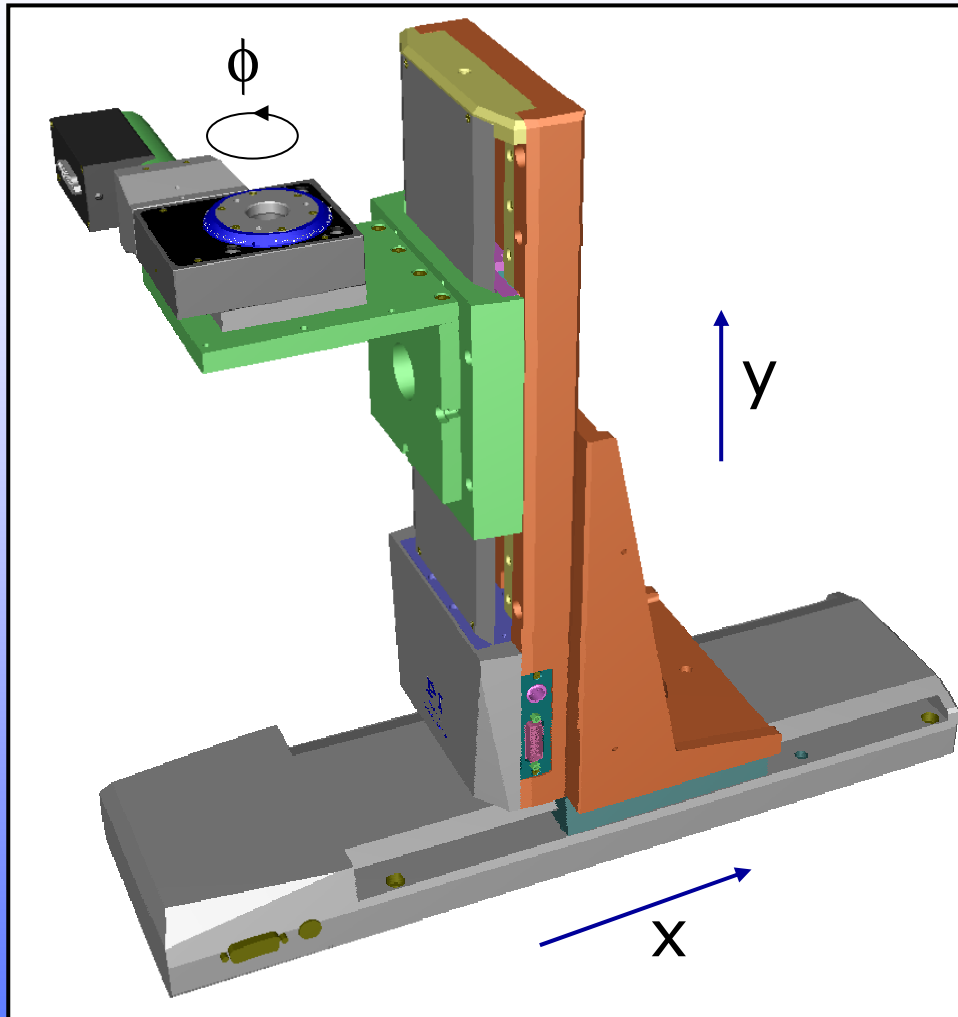

- 10 offers evaluated.
- Decision for PI-offer as best choice for price-performance ratio, with respect to our needs.
- Expected preciseness in the order of a few microns.
- Stage ordered already complete assembled and surveyed with steering components and software
- Delivered to DESY in October 2006, but had to be sent back since it came unassembled and uncalibrated.
- Will be set up in the lab for testing in November
- Ready for integration in spring 2007

Carsten Muhl/DESY



Senor Boxes are Under Development

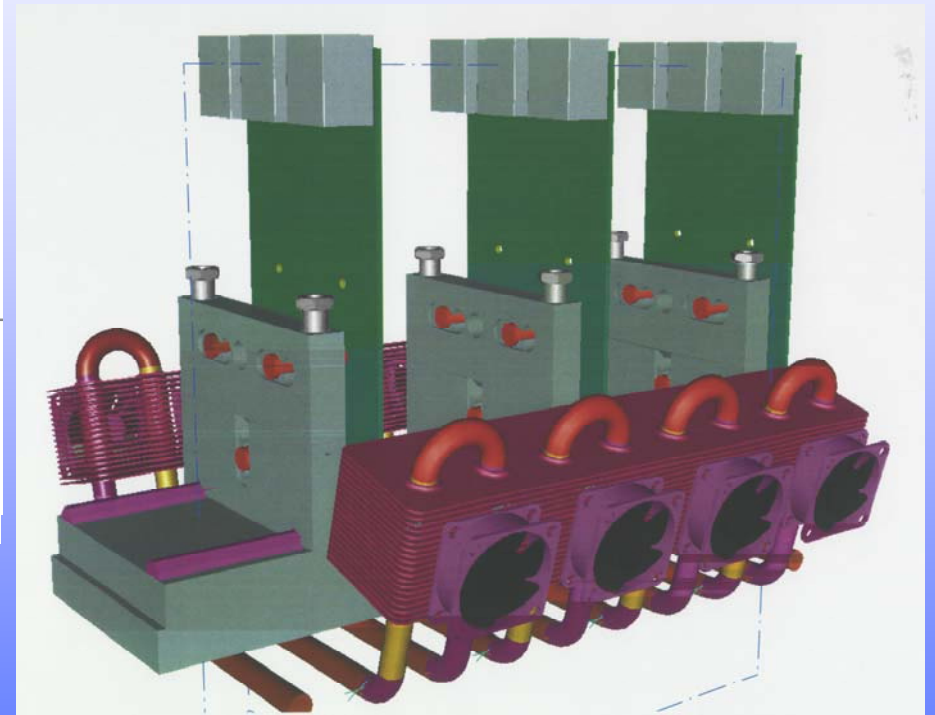
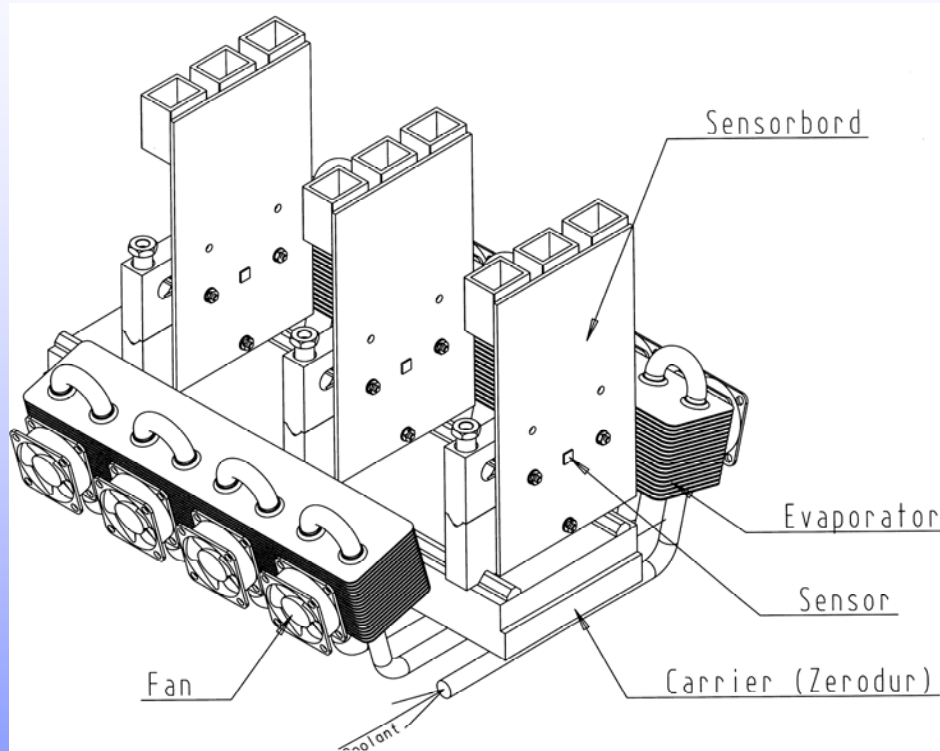

Pictures show a first design iteration. Cooling and fixations will change!

Carsten Muhl/DESY



Cooling for Sensor Boxes and DUT



Regulated Cold N2 Gas System

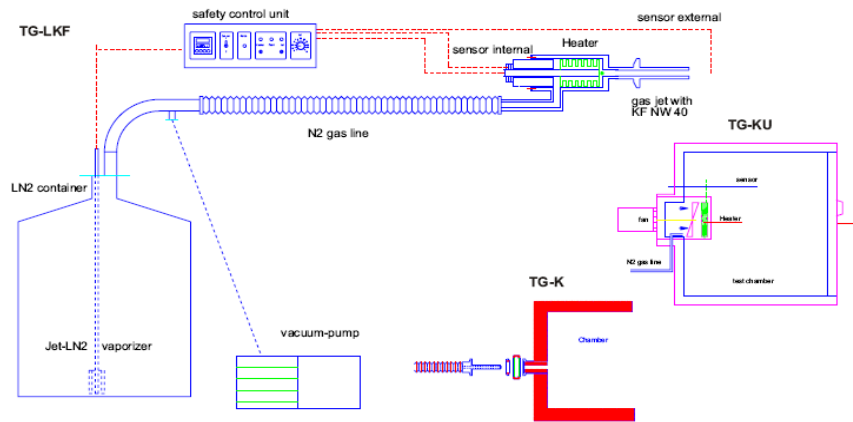

The TG-LKF 63/50 KALTGAS system includes a standard safety control unit (a temperature controller with current value/set point display and a safety controller), a KF-NW 50 siphon with an LN2 vaporizer (Jet), a flexible, evacuable N₂ gas line with an integrated post-heating module (heater), a PT100 temperature sensor and a vacuum pump with accessories.

Cold Gas System : +170°C ...-180°C
(N₂-Stream Temperature Accuracy ±0,1°C)

- Expensive
- Safety regulations required
- +Quick
- +Precise
- +Wide range of temperature
- +DUT cooling possible with the same device

Carsten Muhl/DESY

Evaporation Cooling Based on R404A

		R404A/R507											
		Kälteleistung in W						Verdampfungstemperatur in °C					
Liquefier 1		-45	-40	-35	-30	-25	-20	-15	-10	-5	0	5	10
Liquefier 2		64	85	110	141	177	218	265	318	378	-	-	-
		-	-	-	-	-	-	265	314	377	450	528	588

- Large area for evaporator needed →
Increases Size of sensor box
- 2 systems needed between -40°C and +10°C
- Slow and complex regulation
- +No danger
- ±Standard Components except evaporator

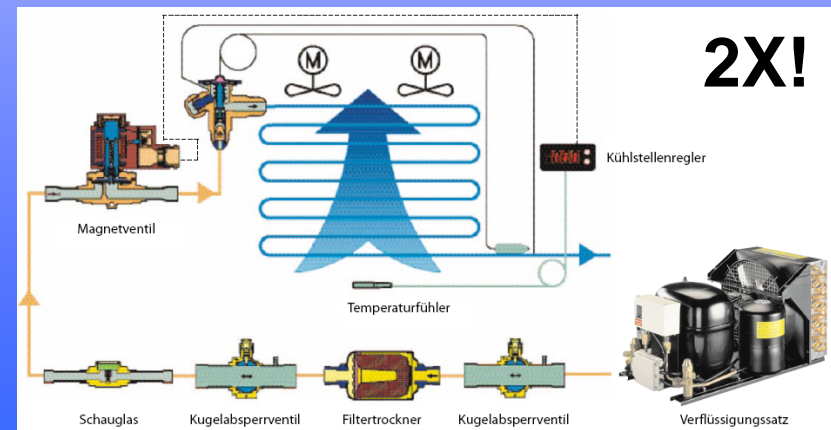

Simulations of EUDET Telescope



ILC Software Tools

- Full simulation: Mokka (based on Geant 4) and MySQL database
- Straight line track fit
- Output: LCIO format files
- Stored information: hit position, deposited energy, ...
- Analysis: Marlin and Root
- Simulated 50000 events
- Assumed telescope plane intrinsic resolution – 3 μm (hit positions are smeared)

Tatsiana Klimkovich/DESY

Symmetric geometry

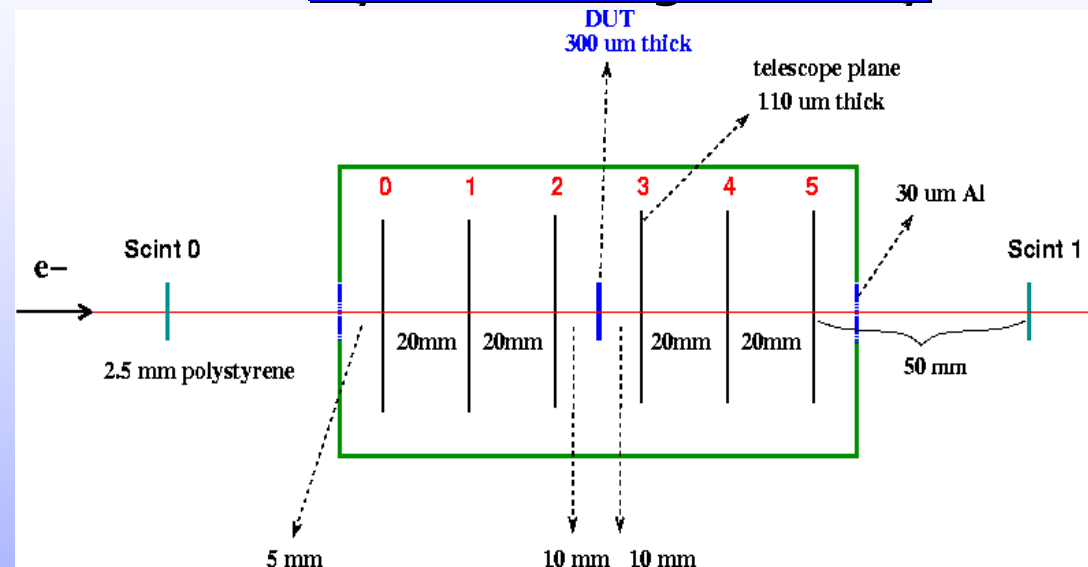

Asymmetric geometry

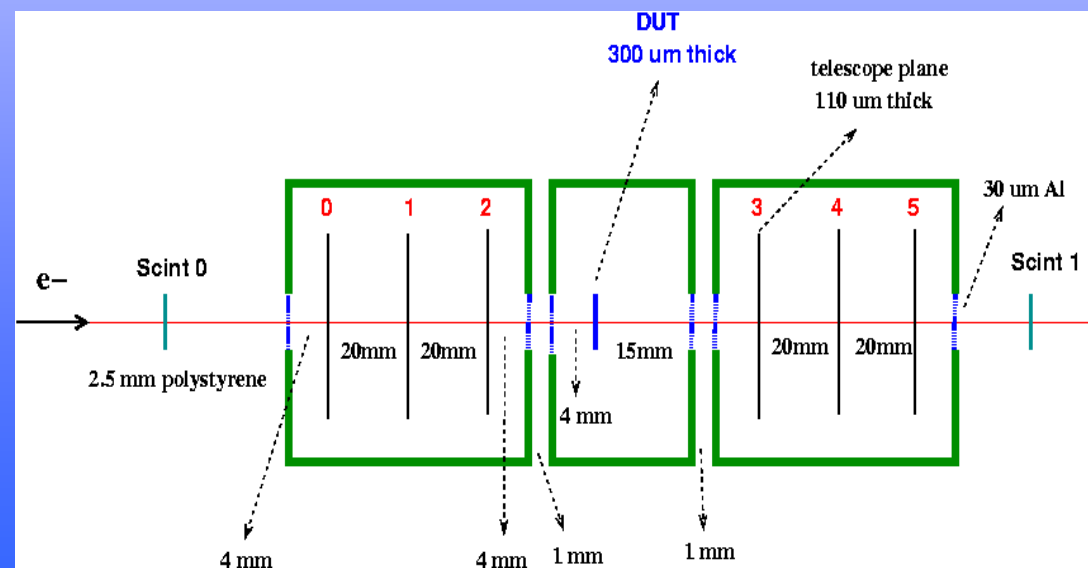

Validation of Multiple Scattering Model



- For small scattering angle **Gaussian approximation** is used for the width of the projected angular distribution:

$$\theta_0 = \frac{13.6 \text{ MeV}}{\beta c p} z \sqrt{\frac{x}{X_0}} \left[1 + 0.038 \ln\left(\frac{x}{X_0}\right) \right]$$

To check the validity of MS description

- Simulate silicon wafer of 300 um thickness
- Shoot 1 GeV electrons (100000 events)
- Look at the projection of scattering angles
- Theory prediction: **0.602 mrad**

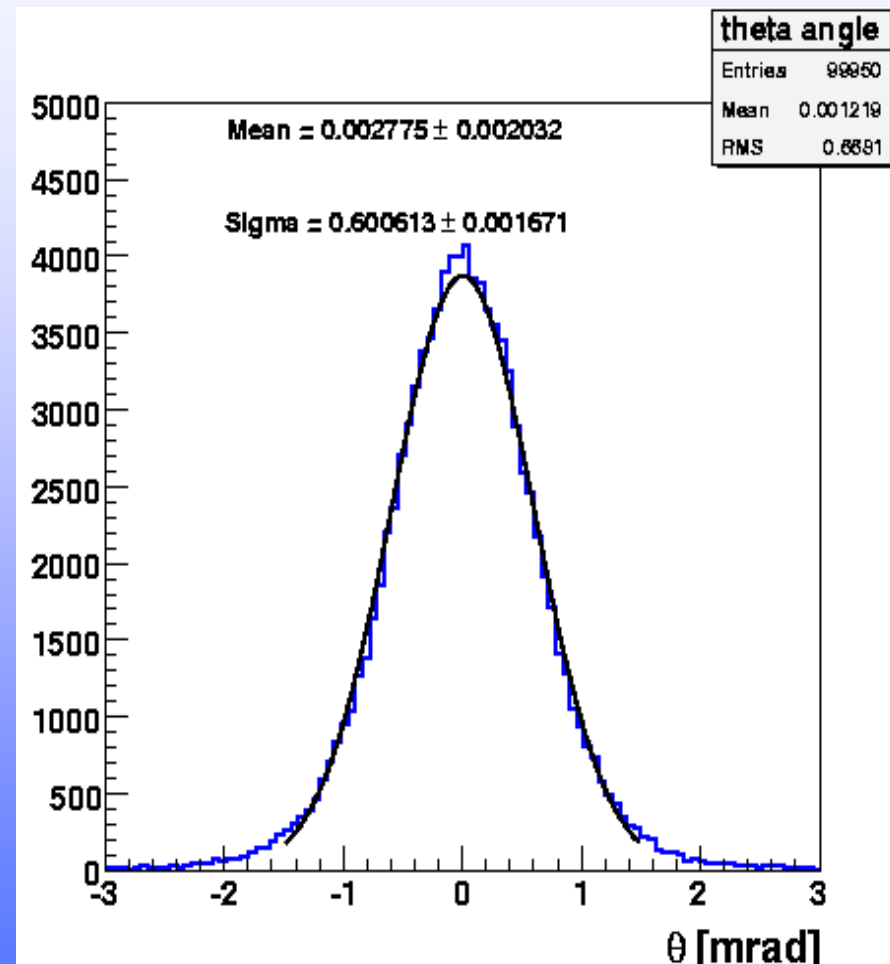

Tatsiana Klimkovich



Results



Comparison of new simulation (Mokka) with Prague simulation (Geant 4) for 6 plane symmetric geometry

Comparison of different geometries (Mokka simulation, after cuts on chi2 and track slope):

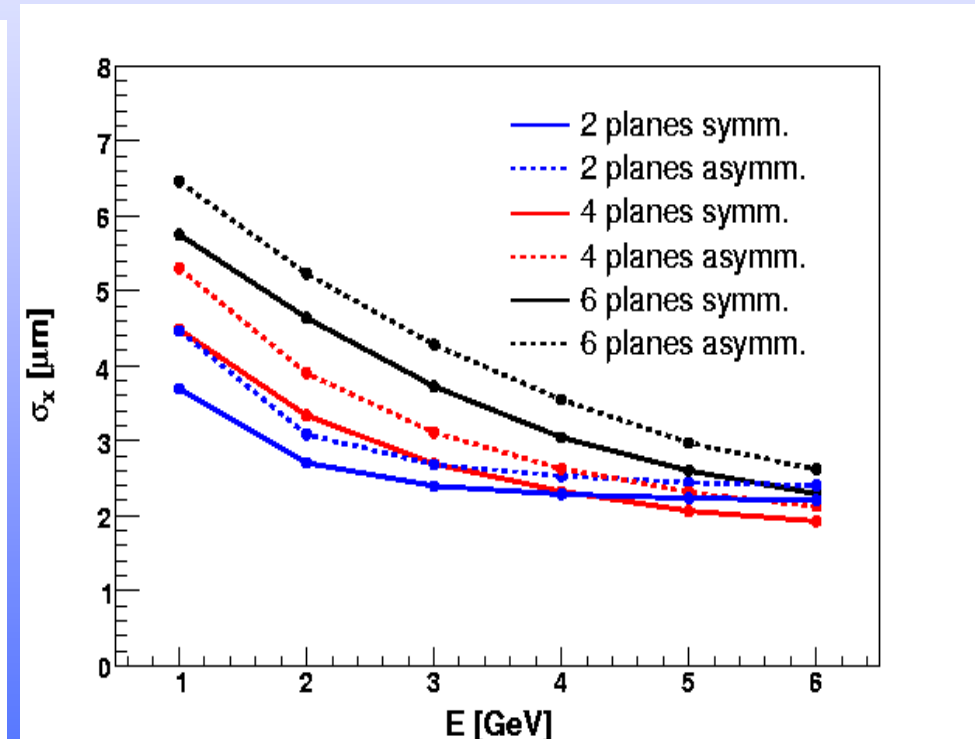
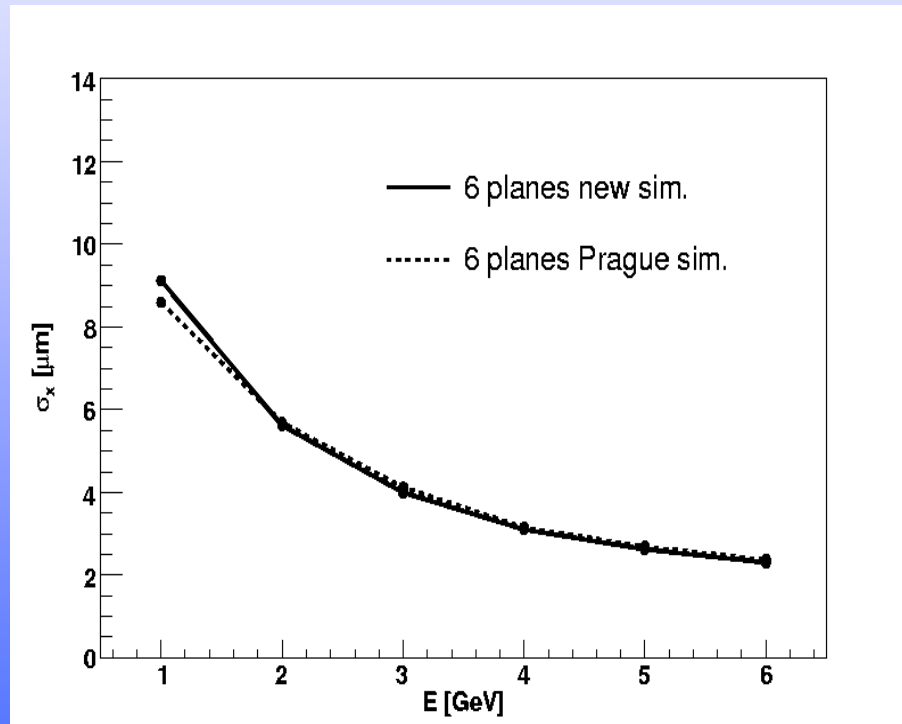

Note: Straight line track fits!

Tatsiana Klimkovich/DESY





HiRes Effect

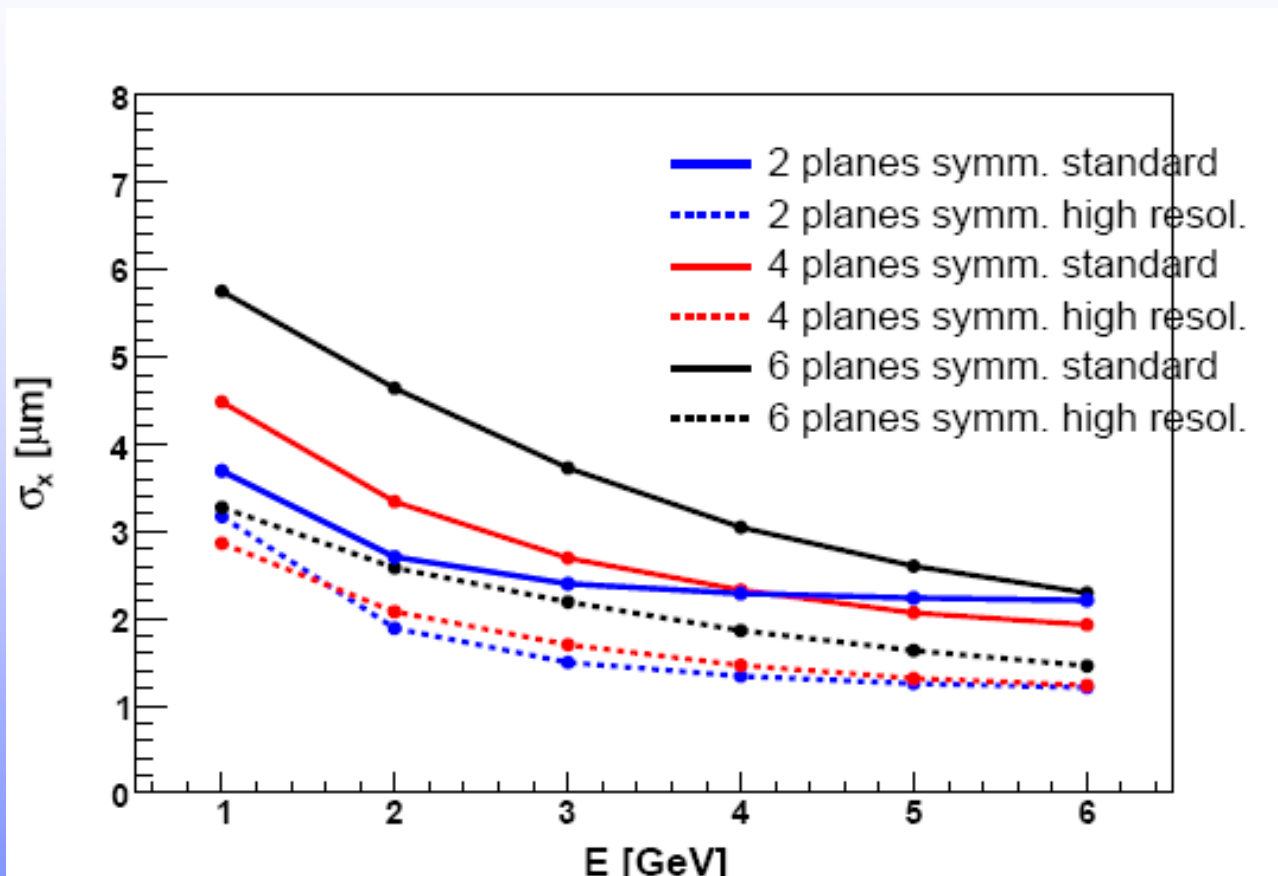

- Standard: all planes have 3 μm resolution
- HiRes: 2 planes closest to DUT have 1.5 μm resolution
- Achieve: 1.5 (2) μm on DUT at 6 (3) GeV/c

Tatsiana Klimkovich/DESY





First look at Alignment

Alignment package Millepede

- When detector is ready a proper software alignment will be an important issue for telescope precision
- \implies Test alignment procedures with simulated data
- Alignment package **Millepede** is developed by Volker Blobel (Uni Hamburg)
- Used in H1, ZEUS, CMS for tracker alignment
- Aligns all planes simultaneously
- Based on linear least squares fits
- Simulated 50000 events (6 GeV electron beam) for 6-plane symmetric telescope configuration without DUT

First try to find alignment parameters

x shifts

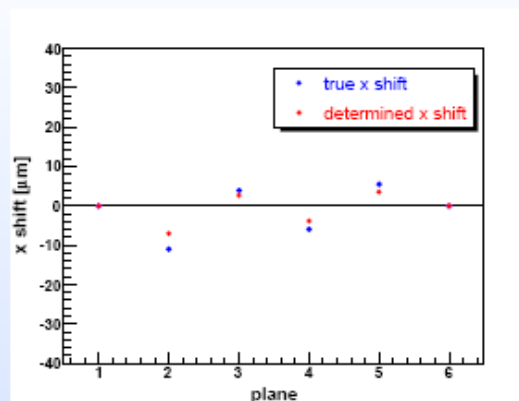

y shifts

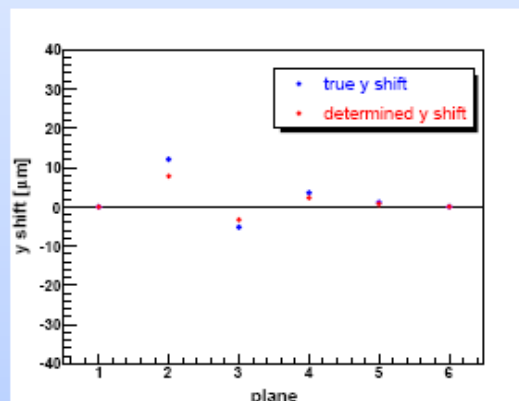

Should investigate more, play with constraints, etc.





Another Study

6 GeV Electrons

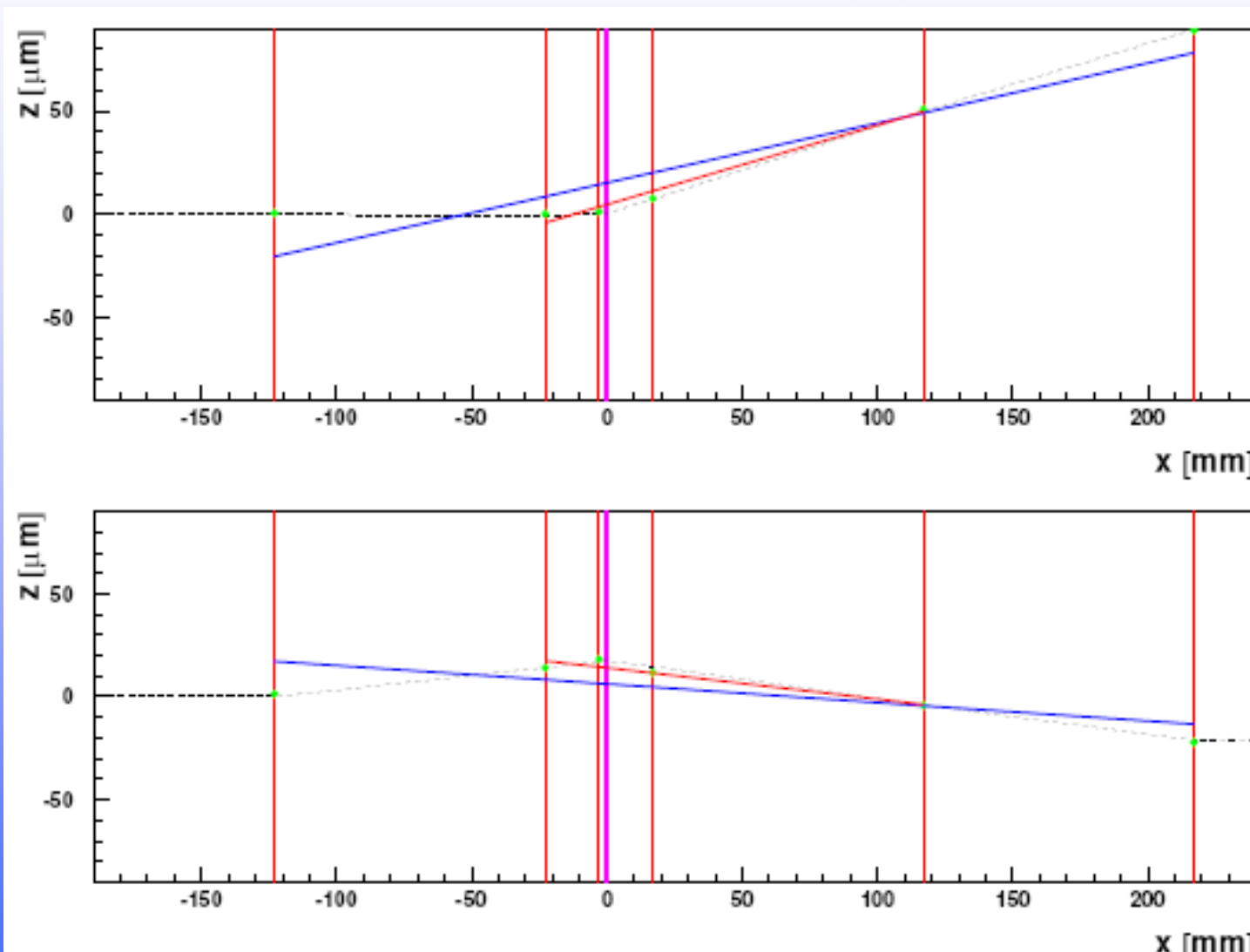

A. F. Zarnecki/Warsaw





Geometries of Interest

NW-WN



NW-WN

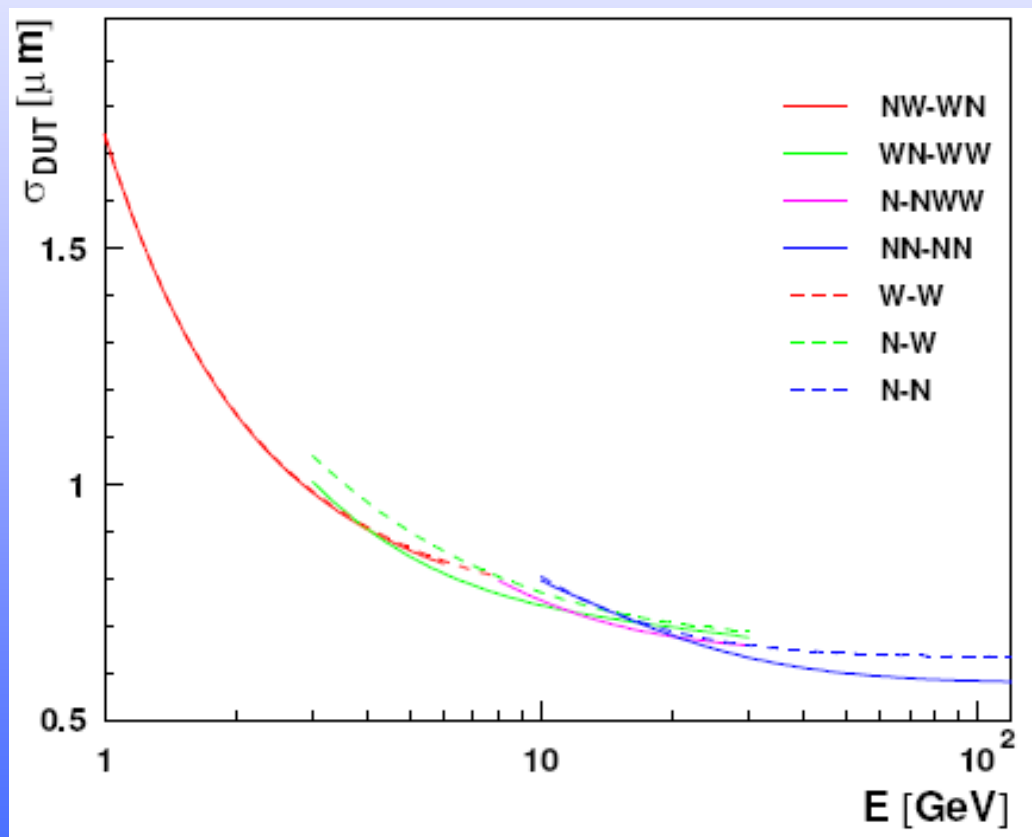
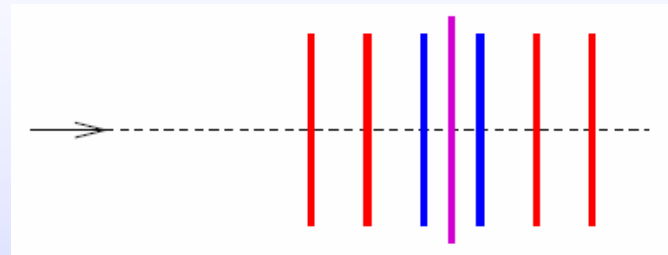

Flexibility for the geometrical setup is needed **A. F. Zarnecki/Warsaw**



Mimostar2 - Temperature Scan

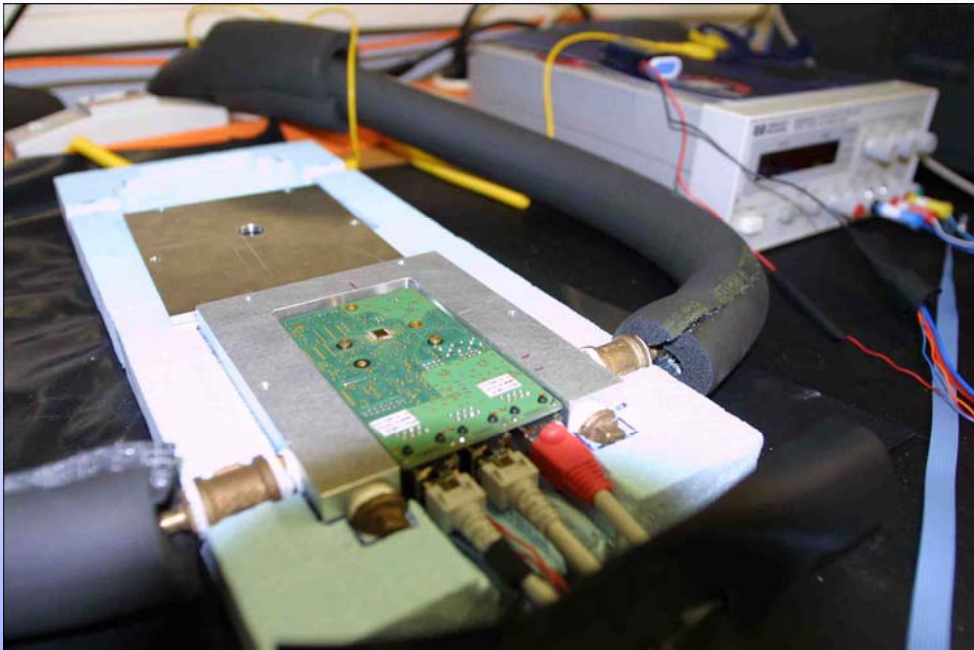

- Simple setup with Strasbourg hardware to do pedestal and source measurements
- Also source measurements were done (Fe55)
- Cooling keeps Mimostar2 at constant temperature
- Temperature Sensor inside cooling box

Lukasz Maczewski/Warsaw/DESY



Pedestal and Noise Distribution

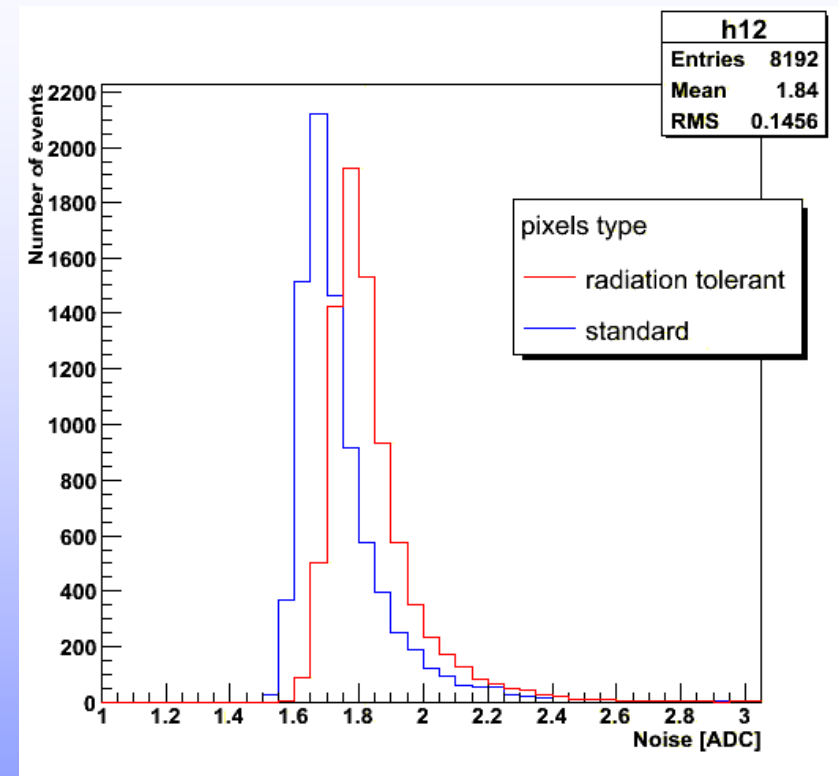
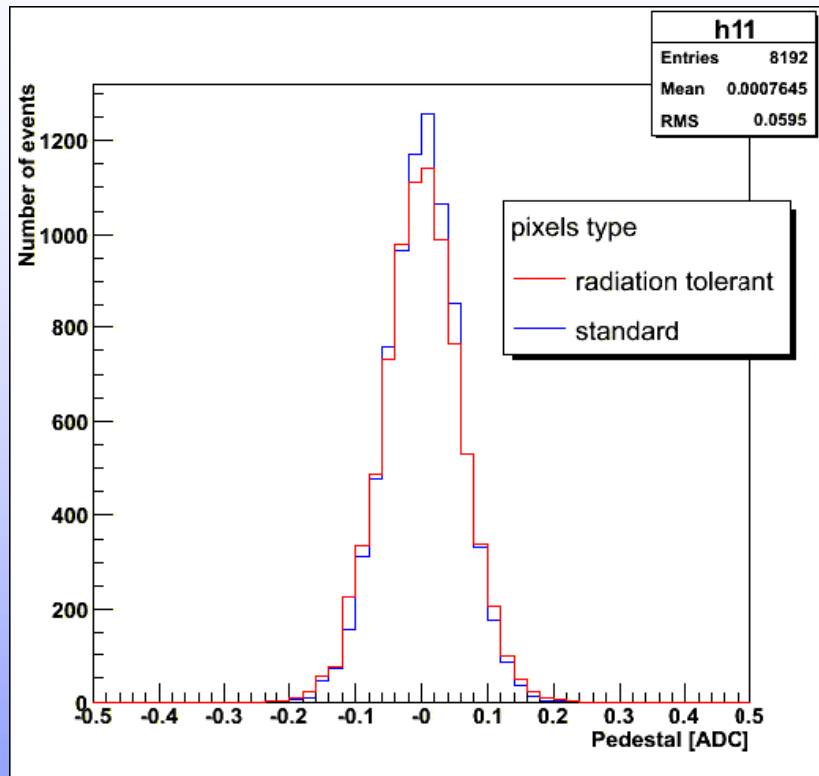

- Measurements done at 21°C
- Pedestal is distributed around 0 ADC
- Noise in the matrix with the radiation tolerant pixels is higher than in the matrix with the standard pixels

Lukasz Maczewski/Warsaw/DESY





Summary

- Testbeam area ready for the magnet and telescope
- Magnet will arrive at DESY in November
- $XY\phi$ table for telescope delivered in October but went back for calibration
- Mechanical setup and cooling for telescope under development
- Different Simulations are being done: First results indicate that a flexible geometrical setup is required
- Sensor technology is broadly being investigated.

