



# Damping Ring Design and Technical Issues

Michael S. Zisman

Center for Beam Physics

Accelerator & Fusion Research Division

Lawrence Berkeley National Laboratory

for

Jie Gao (IHEP), Susanna Guiducci (INFN-LNF), and  
Andrzej Wolski (Cockcroft Institute)



# Outline

- Introduction
- Design Issues
- Design Status
- Low Emittance Issues
- R&D Program
- Summary



# Introduction

- DR group currently focuses on two major activities
  - **conceptual design of DR and ancillary systems for RDR**
    - along with the corresponding cost estimate
  - **organization and execution of R&D program in support of DR design**
    - focused on RDR issues to date
    - planning and organizational effort under way for TDR stage to follow
- RDR design meets specifications of baseline configuration
  - **RDR lattice has evolved somewhat in response to conventional facilities requests**



# Design Issues

- Damping ring is challenging
  - **requirement for low emittance**
    - DR must reduce positron emittance by factor of  $\approx 10^6$
  - **requirement for adequate dynamic aperture**
    - in wiggler-dominated low-emittance lattice
  - **requirement for good acceptance for injected positron beam**
    - positrons have large emittance (10 mm-rad) and energy spread ( $\leq 1\%$ )
  - **requirement for acceptably low instability thresholds**
    - must provide highly stable beams for downstream systems
      - with high beam current and many bunches



# EDR Baseline Parameters

---

$C$ (km)	6.6
$E$ (GeV)	5
$N_b$	2700-5400
$I_{\text{avg.}}$ (mA)	400
$\tau_x$ (ms)	$\approx 25$
$\epsilon_{x,y}$ (nm)	0.5/0.002
$\sigma_l$ (mm)	6

---

NOTE: Beam current halved for 2 PDR baseline

Design value; specification  $\leq 0.8$  nm



# RDR Planning

- Plan for RDR was established by DR ASLs in consultation with DR collaboration
  - DR contact persons identified to help with preparation of component specifications and parts counts
    - specifications recorded on Component Specification Sheets
      - includes references to information sources and contact info for person responsible
    - <https://wiki.lepp.cornell.edu/ilc/bin/view/Public/DampingRings/ReferenceDesignReport> set up by M. Palmer et al.
    - these serve as primary reference for technical and global groups responsible for DR component design
  - A. Wolski serves as DR Specifications and Costs Coordinator
    - collects specifications and maintains current cost roll-up
    - acts as DR interface with DCB



# RDR Contact Responsibilities

- Responsibilities shared among DR ASLs

Technical or Global Group	DR AS Contact	TG or GG Contact
Magnets	Mike Zisman	John Tompkins
Cryogenics - wiggler	Mike Zisman	Laurent Tavian
Cryogenics - RF	Susanna Guiducci	Laurent Tavian
RF Power	Susanna Guiducci	Shigeki Fukuda
Instrumentation	Susanna Guiducci	Mark Ross
Controls	Susanna Guiducci	John Carwardine
Vacuum	Andy Wolski	John Noonan
Conventional Facilities/Siting	Andy Wolski	Tom Lackowski
Design Cost Board	Andy Wolski	Jean-Pierre Delahaye
Dumps and Collimators	Mike Zisman	Tom Markiewicz
Installation	Mike Zisman	Fred Asiri
Commissioning, Ops, Reliability	Mike Zisman	Tom Himel



## Design Status

- Lattice ("OCS2") (Xiao) satisfying basic DR requirements presented (Gao) at Bangalore
  - interactions with CFS group identified desirability of minimizing number of RF/wiggler sections
    - reduces required number of access shafts (cost issue)
  - official RDR version of lattice ("OCS6") posted <https://wiki.lepp.cornell.edu/ilc/bin/view/Public/DampingRings/WebHome>
    - alternative FODO configuration being studied at IHEP (Sun)
      - potential for improved dynamic aperture
- Technical subsystem specifications set by lattice
  - having "stable" baseline lattice essential for developing a consistent cost estimate
    - our specifications based on OCS6





# RDR Lattice

- $\approx$ sixfold symmetry; six straight sections
  - 4 short straights for RF and wigglers (249 m)
    - was 6 straights
  - 2 long straights (400 m)
    - injection and extraction
    - beam abort and misc.
  - 6 arcs (818 m)
    - each has 18 TME cells + dispersion suppressor

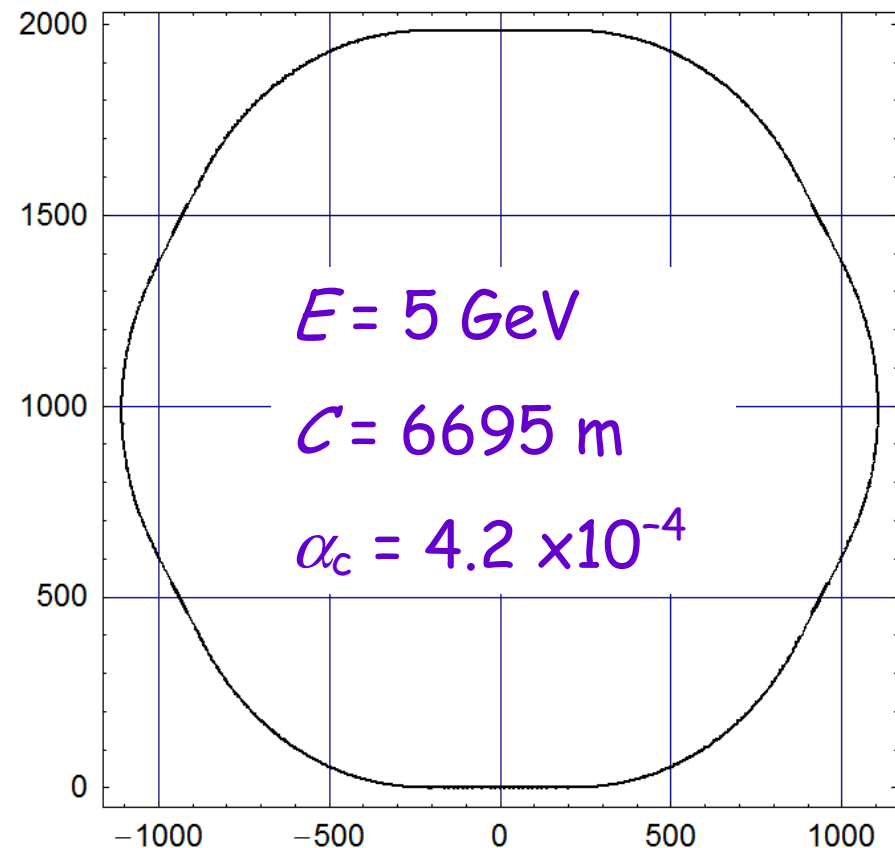



# Lattice Parameters

- General parameters for the OCS6 lattice

Circumference [m]	6695.057	RF frequency [MHz]	650
Energy [GeV]	5.0	Synchrotron tune	0.0958
Harmonic number	14516	Synchronous phase [deg]	169
Arc cell type	TME	RF acceptance [%]	2.7
Horizontal tune	52.397	Natural bunch length [mm]	6.00
Vertical tune	49.305	Natural energy spread [ $10^{-3}$ ]	1.28
Natural chromaticity ( $x, y$ )	-63, -62	Average current [mA]	402
Momentum compaction [ $10^{-4}$ ]	4.20	Mean horizontal beta function [m]	13.1
Energy loss/turn [MeV]	8.69	Mean vertical beta function [m]	12.5
Transverse damping time [ms]	25.7	Synch. radn. integral $I_1$ [m]	2.8116
Longitudinal damping time [ms]	12.9	Synch. radn. integral $I_2$ [ $m^{-1}$ ]	0.9872
Natural emittance [nm]	0.515	Synch. radn. integral $I_3$ [ $m^{-2}$ ]	0.08876
Norm. natural emittance [ $\mu m$ ]	5.04	Synch. radn. integral $I_4$ [ $10^{-4}m^{-1}$ ]	1.8888
RF voltage [MV]	48.1	Synch. radn. integral $I_5$ [ $10^{-5}m^{-1}$ ]	1.3870



# OSC6 Lattice Issues

- Large  $\alpha_c$  good for beam stability
  - but substantial RF (48 MV) needed for 6 mm bunches
- Reduction in lattice periodicity has markedly decreased dynamic aperture
  - under investigation now

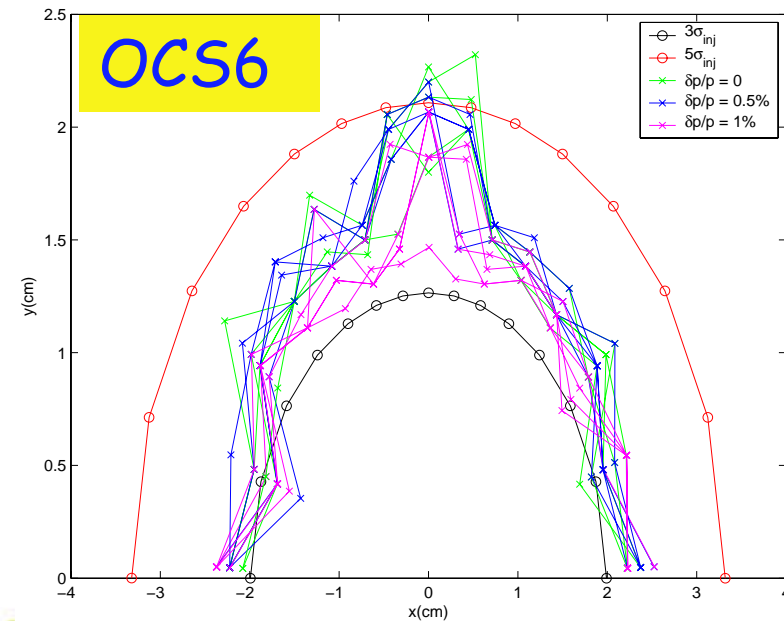
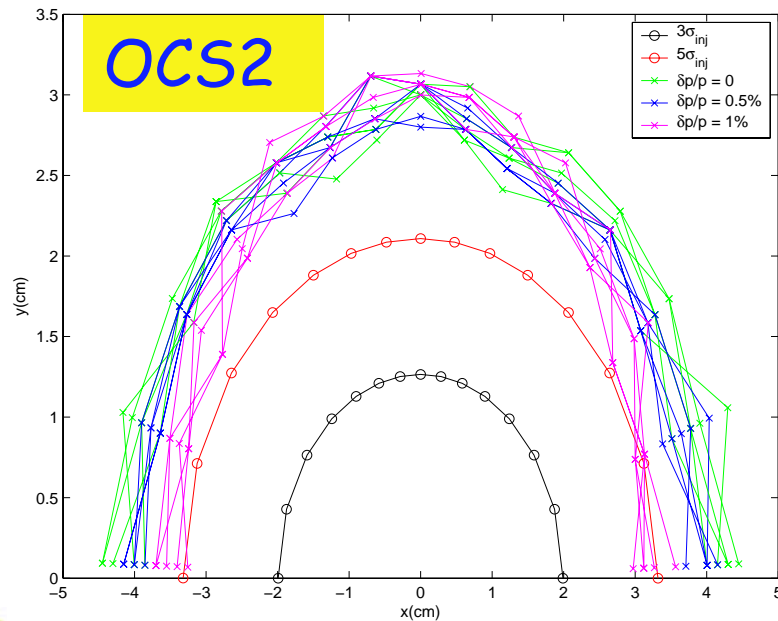



# Tunnel Layout

- Representative layout for baseline case (2 PDRs)
  - indicated vertical spacing too small unless we can "stagger" RF locations of upper and lower rings

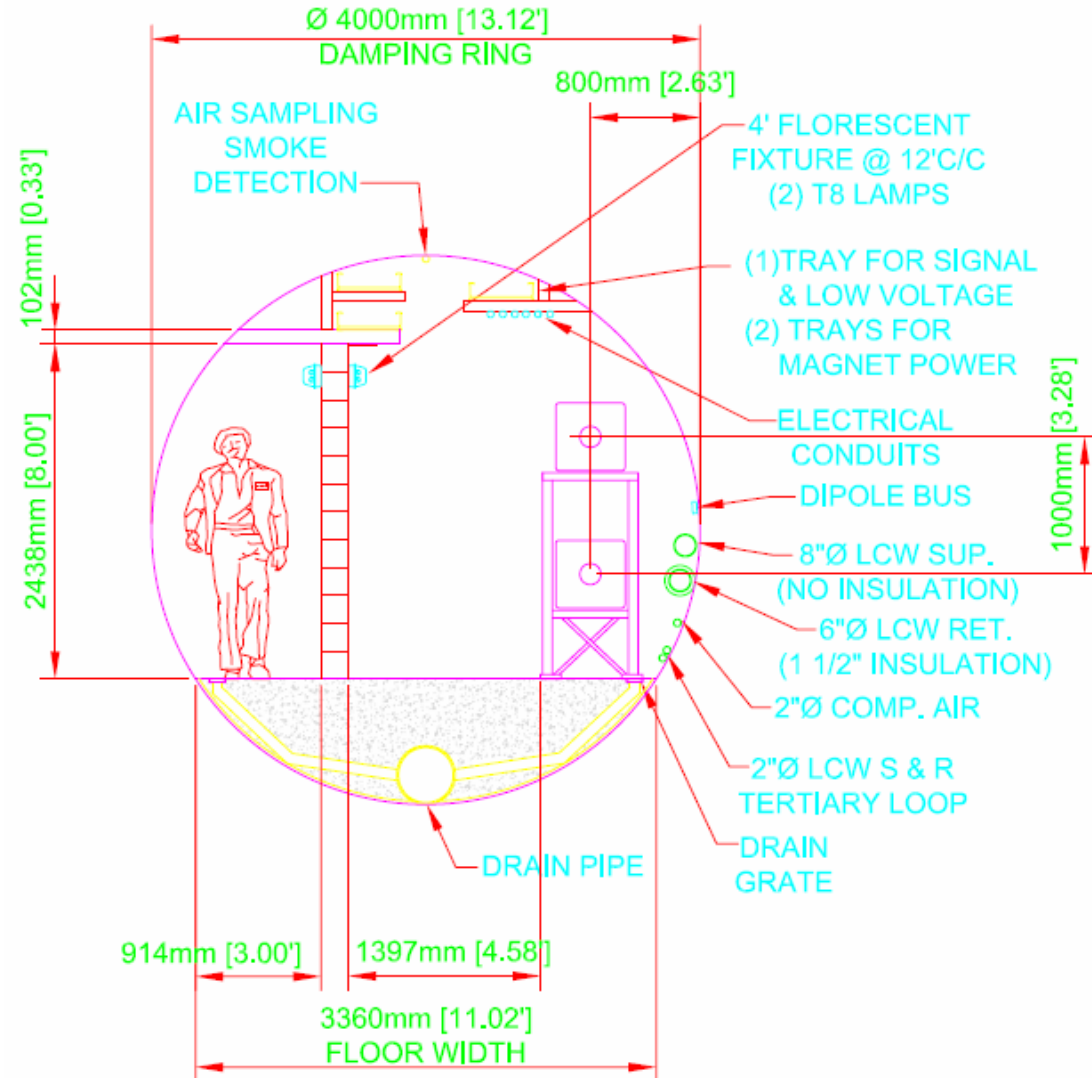



# Alcove Layout

- Four major alcoves ( $18 \times 10.5 \times 10 \text{ m}^3$ )
  - each with 9 m shaft
- Wiggler, RF equipment located here
  - also power supplies, controls equipment, etc.

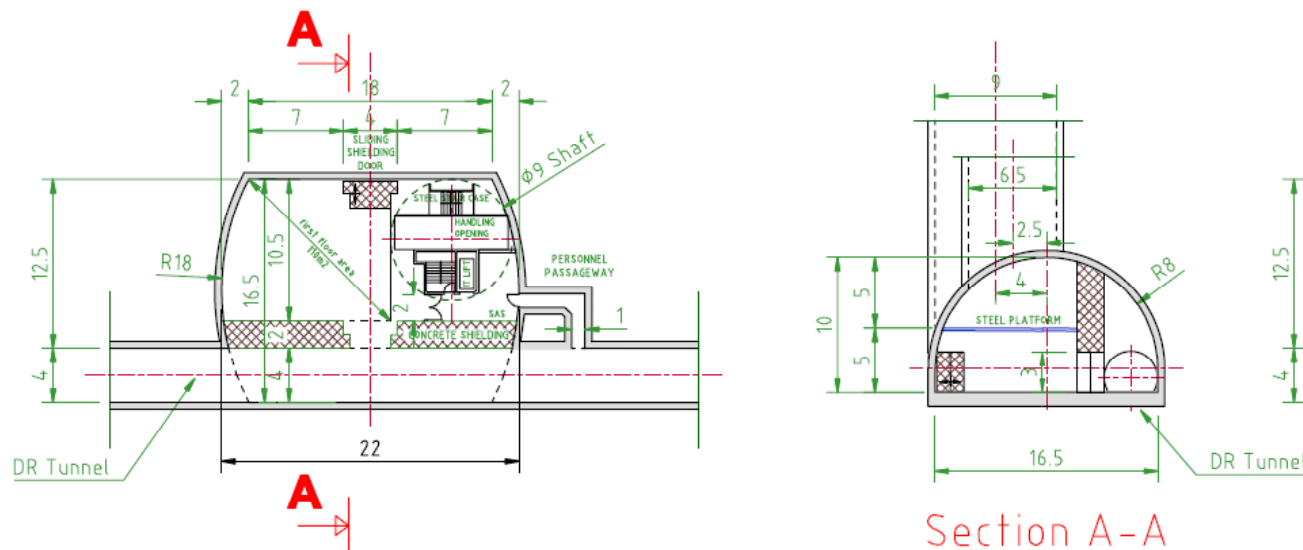



# Wiggler Design

- Baseline design based on Cornell SC wiggler (**Urban**)
  - permits high field with large aperture
    - alternative designs still being examined (PM or resistive)
  - vacuum chamber concept to handle heat load and provide adequate pumping developed (**Marks, Plate**)

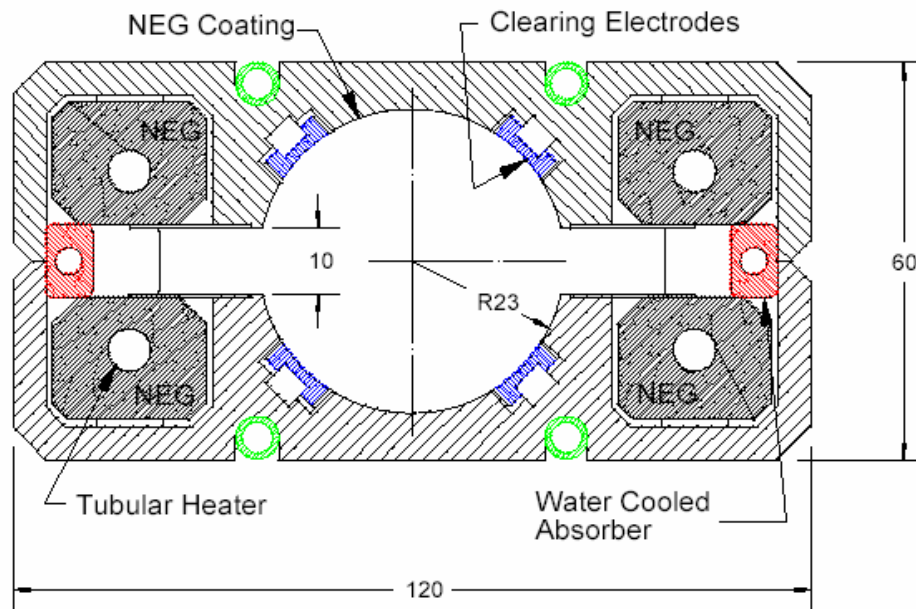

Material: welded Al, NEG coated

$P_{CO} = 0.7$  nTorr

Power density:  $3$  W/mm<sup>2</sup>

Power: 26 kW/wiggler (13 kW each absorber)



## e-Cloud Suppression (1)

- Baseline design called for 2 PDRs
  - driven by concerns about ECI
- Recent work on mitigation techniques gives good hope of handling ECI in single PDR
  - weak solenoids for drifts
  - clearing electrodes and/or grooved chambers in magnets (+ NEG coating)
- CCR submitted after Vancouver meeting
  - asked that ECI R&D have high priority to validate efficacy of proposed cures
    - until then, design should preserve option to return to 2 PDRs



# e-Cloud Suppression (2)

- Possible "cures"

Pivi, Raimondi

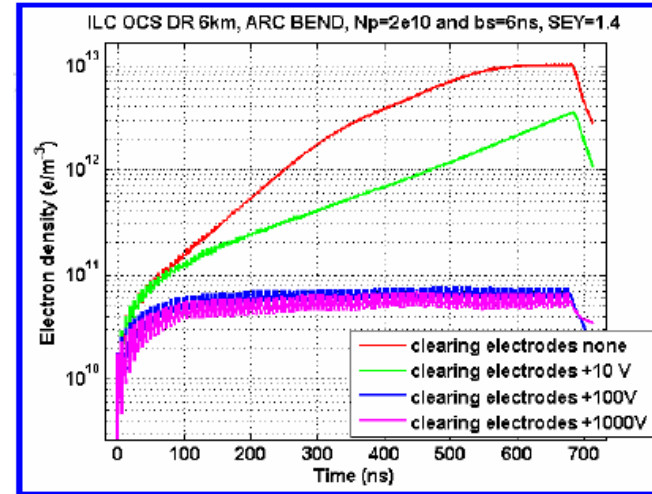
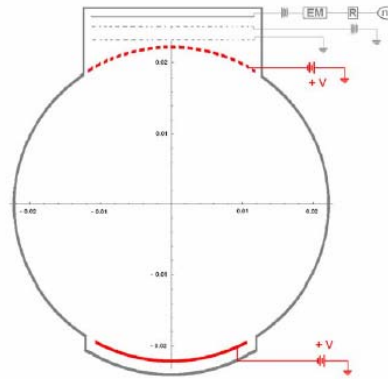

Wang, Raubenheimer

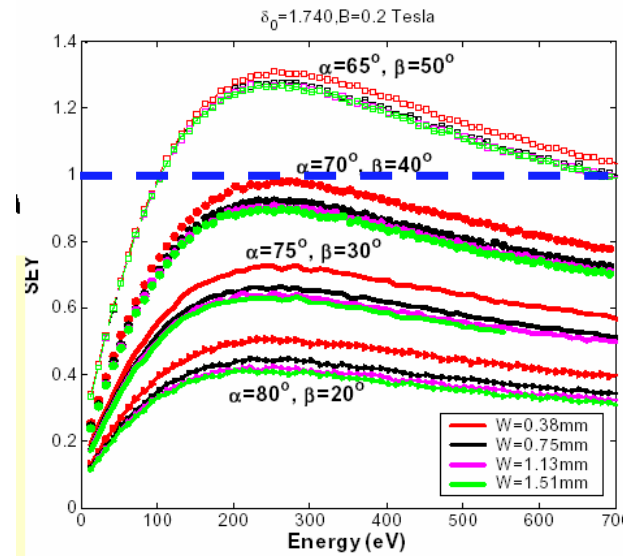
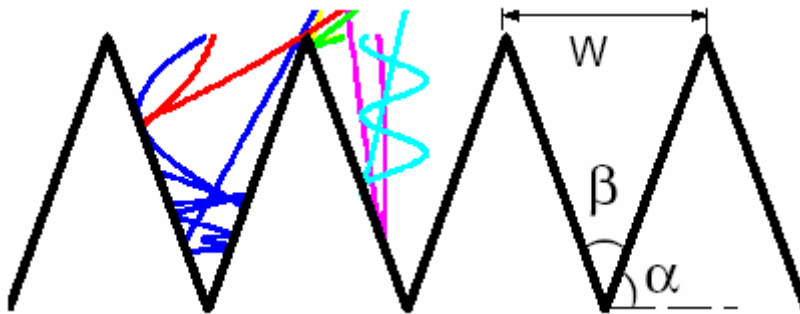

B=0.2 Tesla (dipole magnet of ILC)





# RF System

- Adopted 650 MHz system
  - gives flexibility for gaps in bunch train
  - provides short bunches with lower voltage
  - convenient subharmonic of ML RF system
- Klystron will be scaled from existing designs to minimize development costs
  - klystron approach discussed with industry; incremental costs for development expected to be minor
    - consistent with klystron experience from PEP-II (500 → 476 MHz)
  - no present plans to build prototype
    - RDB or MAC may wish to weigh in on this question



# RF Parameters

- Main RF parameters

Damping rings parameters		
	$e^-$ ring	$e^+$ rings
Energy (GeV)	5	5
Number of bunches per train	2767	1384
Number of particles per bunch	$2 \times 10^{10}$	$2 \times 10^{10}$
Average current (A)	0.4	0.2
Energy loss per turn (MeV)	8.7	8.7
Beam power (MW)	3.5	1.75
Bunch current (mA)	0.14	0.14
Total RF voltage (MV)	48.1	48.1
Circumference (km)	6.695	6.695



# RF Layout (schematic)

- RF located in 4 straight sections
  - station comprises 1 klystron powering 4 cavities
    - 2 stations per straight section

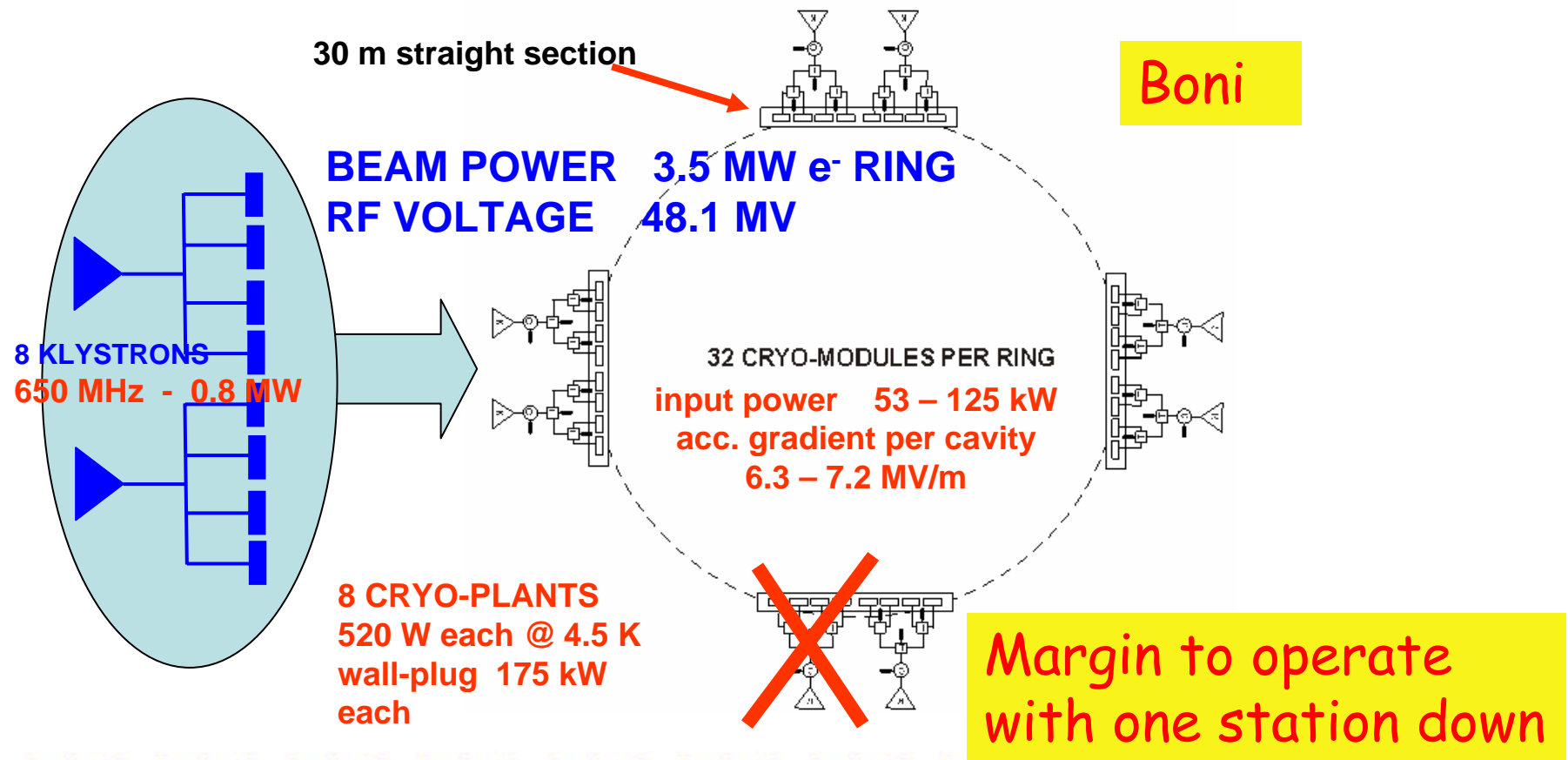



# Cryomodules

- Cryomodule will be scaled from either CESR or KEK-B design (both 500 MHz)
  - some redesign of cryostat and coupler needed
    - this will require prototyping

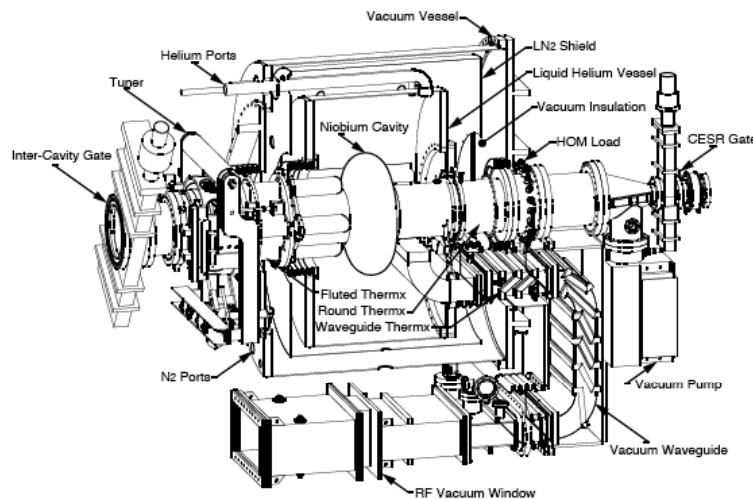

**CESR Cryomodule**

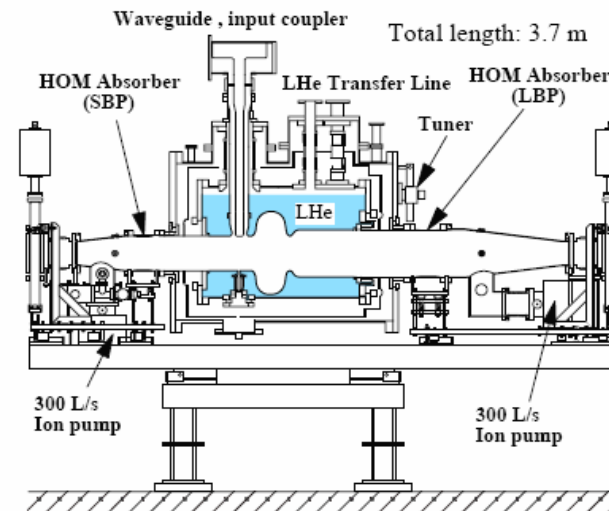

**KEK-B Cryomodule**



# Emittance Requirements

- Nominal values
  - Normalized horizontal emittance  $\gamma\epsilon_x = \leq 8 \mu\text{m}$
  - Normalized vertical emittance  $\gamma\epsilon_y = 20 \text{ nm}$
  - Natural horizontal emittance  $\epsilon_x = \leq 0.8 \text{ nm}$
  - Natural vertical emittance  $\epsilon_y = 2 \text{ pm}$
- Minimum vertical emittance achieved at KEK-ATF was  $\epsilon_y = 4.5 \text{ pm}$ 
  - $\Rightarrow$  DR requirement will not be easy!



# Vertical Emittance Growth

- Vertical emittance arises from:
  - **synchrotron radiation opening angle**
  - **vertical dispersion**
    - same mechanism as horizontal emittance
      - quadrupole misalignment
      - sextupole misalignment
      - dipole roll
  - **coupling**
    - transfers some horizontal emittance into vertical plane
      - sextupole misalignment
      - quadrupole rotation



# Emittance Studies To Date

- Low emittance tuning studies performed for Baseline Configuration (BC) lattice (LBNL-59449)
  - OCS (not quite the RDR lattice)
    - calculations will be repeated for new lattice
- Several studies were done on alignment sensitivity
  - Merlin simulations (Wolski)
    - in agreement with analytical formulae
  - SAD low-emittance-tuning studies (Kubo)
- The two programs gave identical results



# Quadrupole Misalignment

- Orbit amplification factor is ratio of rms closed orbit deviation to rms quadrupole displacement
  - example from OCS lattice, orbit amplification = 47

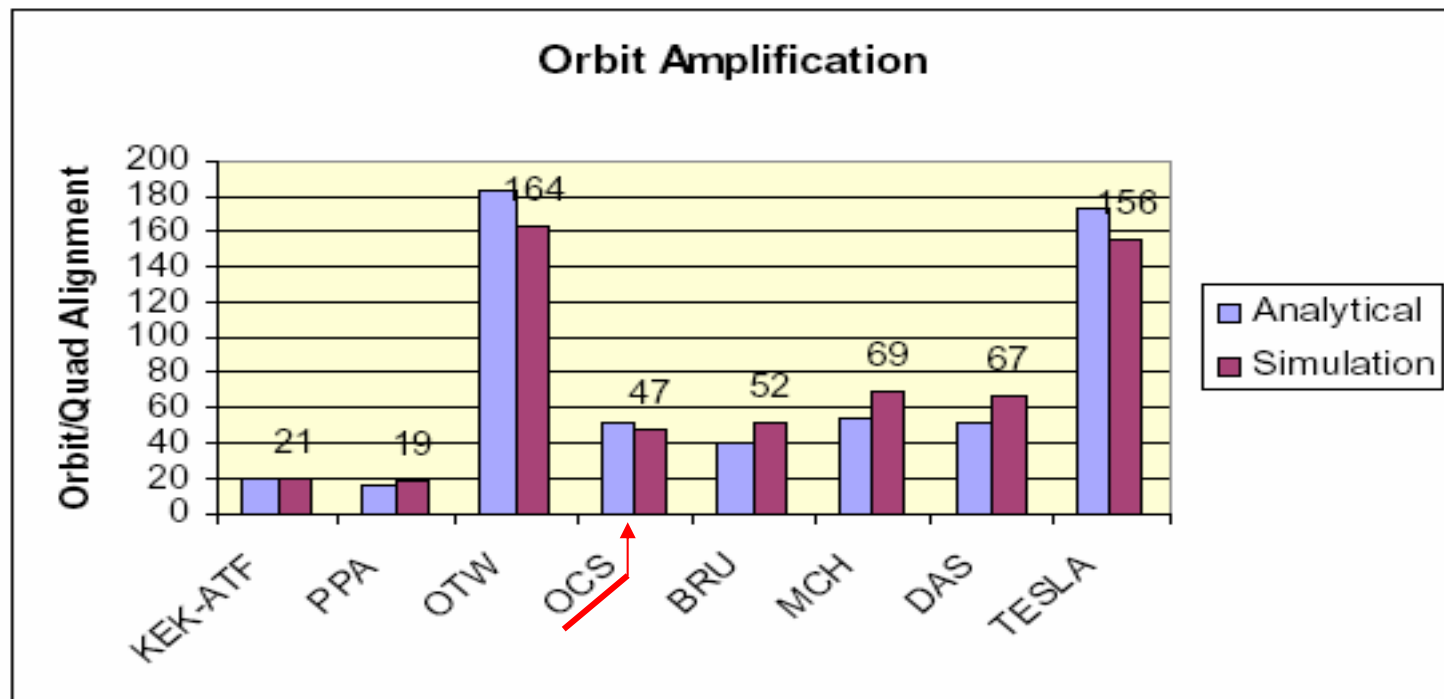





# Sextupole Misalignment

- Sextupole misalignment gives rise to significant emittance increase
  - 10  $\mu\text{m}$  results in 1.06 nm emittance
    - still one of the better lattices studied

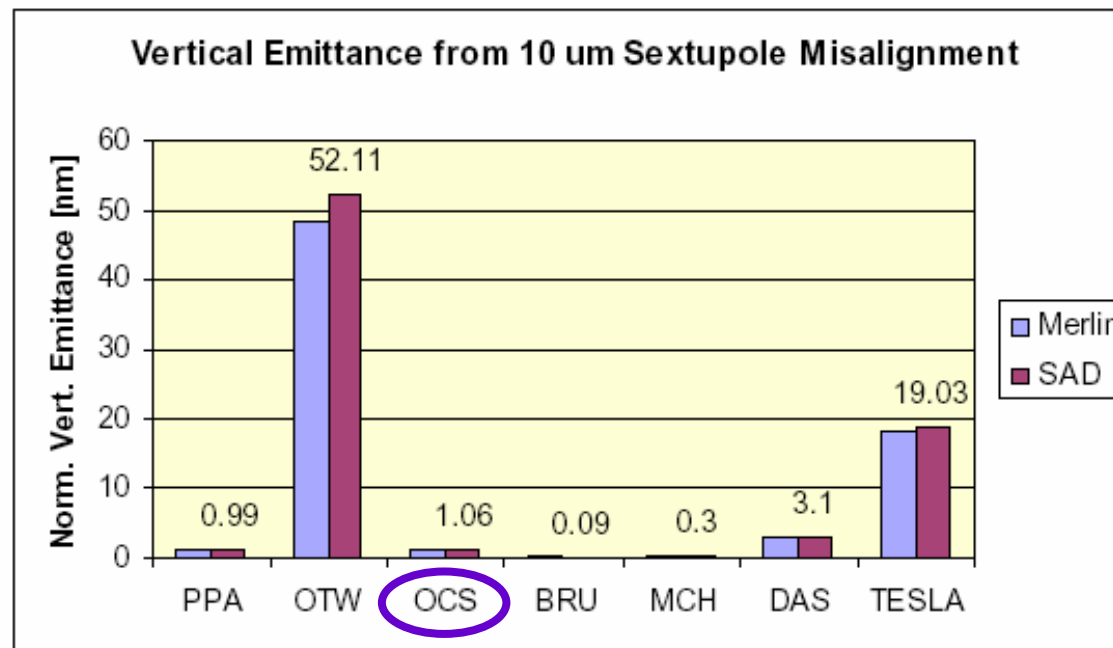



# Quadrupole Roll

- Quadrupole roll also causes significant vertical emittance growth
  - for OCS lattice,  $30 \mu\text{rad} \Rightarrow 5.08 \text{ nm}$

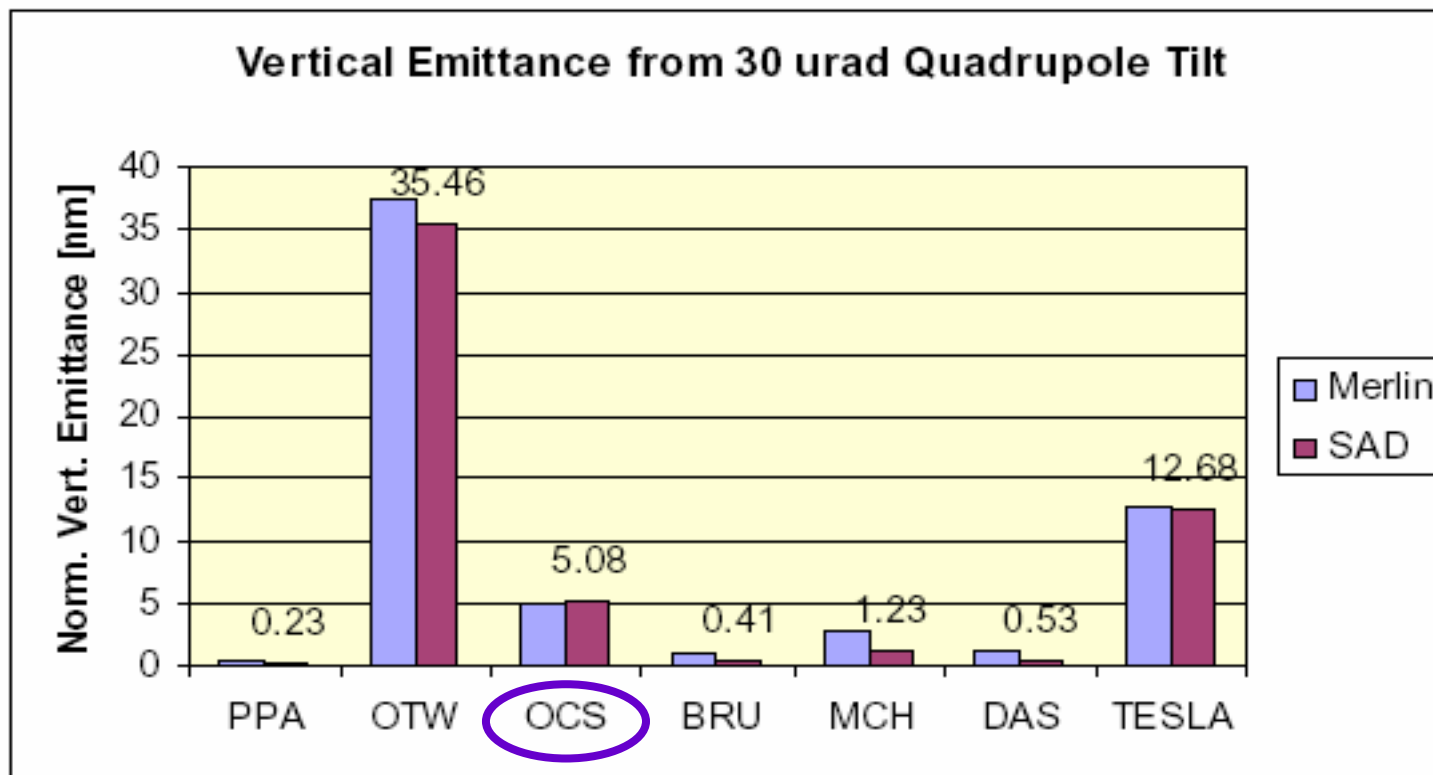



# Tuning Simulations (1)

Initial offsets and tilts:

Magnets 30  $\mu\text{m}$ , 0.3 mrad

BPMs 100  $\mu\text{m}$ , 20 mrad

Using SAD (K. Kubo)

Tuning was applied in three stages:

1. correction of closed orbit distortion (COD);
2. combined correction of closed orbit distortion and dispersion (by steering);
3. correction of coupling (minimizing cross-plane orbit response) using skew quads.

Normalized vertical emittance in nm (target: < 20 nm), averaged over 200 seeds

Lattice	No correction	COD only	COD & dispersion	COD, dispersion & coupling
PPA	879	67.4	4.12	1.74
OTW	101,000	60,400	2,680	1,820
OCS	667	526	106	22.7
BRU	1,630	80.4	2.09	5.05
MCH	4,700	189	6.88	9.27
DAS	10,000	266	22.5	6.12
TESLA	88,100	1,670	29.6	12.6



## Tuning Simulations (2)

- Conclusions from this study
  - OCS has low sensitivity to alignment errors compared with other lattices
    - emittance increase from alignment errors, before correction, is small
  - efficacy of correction scheme for OCS was relatively poor
    - expect that a better choice of dipole and skew quadrupole correctors will fix this
      - already confirmed (next slide)
  - 30  $\mu\text{m}$  alignment tolerance is unrealistically tight\*
    - but not really needed

\*in my personal opinion



## Tuning Simulations (3)

- More optimized correction scheme studied for EPAC06 (**Jones**, MOPLS140)
  - **results confirm (on paper) adequacy of RDR lattice**
    - control room experience could be different
    - "None"  $\Rightarrow$  no correction
    - "CO"  $\Rightarrow$  2 iterations of dipole orbit correction
    - "Full"  $\Rightarrow$  2 iterations of dipole orbit correction and 2 iterations of coupling + dispersion correction using skew quadrupoles

Table 2 Magnet Tolerances

Error	Quadrupoles			Sextupoles		
	<i>None</i>	<i>CO</i>	<i>Full</i>	<i>None</i>	<i>CO</i>	<i>Full</i>
$\Delta Y$ ( $\mu\text{m}$ )	9.1	108	380	81	100	3548
$\Delta\Psi$ (mrad)	0.084	0.085	2.81	~		



## Next Steps (Tuning)

- Optimize the number and position of dipole and skew correctors
- Compare different correction algorithms and find optimum for this lattice
  - minimum vertical emittance at lowest corrector strengths
- Study sensitivity of correction scheme to magnet and BPM alignment errors
- Continue machine studies (ATF, ALS, CESR-TF,...)



# Intensity Dependent Effects

- Collective effects can potentially spoil the emittance at high single-bunch current
  - e-cloud instability (ECI)
  - intrabeam scattering (IBS)
  - fast ion instability
  - space-charge effects
  - microwave instability
- We are studying all these issues
  - using simulations, hardware tests, beam measurements
    - experiments at high-current, low-emittance test ring, e.g., ATF, CESR-TF or HERA-DR, likely needed to resolve these matters
  - ECI and ion effects accorded very high R&D priority



# Intrabeam Scattering (1)

- DR may have sensitivity to IBS despite high energy
  - ultra-low emittance + high bunch charge is bad combination
- Equilibrium emittance (transverse and longitudinal) results from balance among radiation damping, quantum excitation, and IBS
  - IBS growth depends on phase space density of bunch
  - faster damping mitigates IBS emittance growth
- Calculations of equilibrium emittance in good agreement with experimental results from ATF
  - we know how to estimate the effect of IBS





# Intrabeam Scattering (2)

- Equilibrium emittances calculated for candidate DR lattices (see LBNL-59499)
  - **EDR assumed to have same damping time as PDR**
    - could be slower, due to smaller injected emittance
      - but, IBS sets limit on EDR damping time
    - vertical growth calculated assuming vertical dispersion and betatron coupling contribute equally to  $\varepsilon_y$

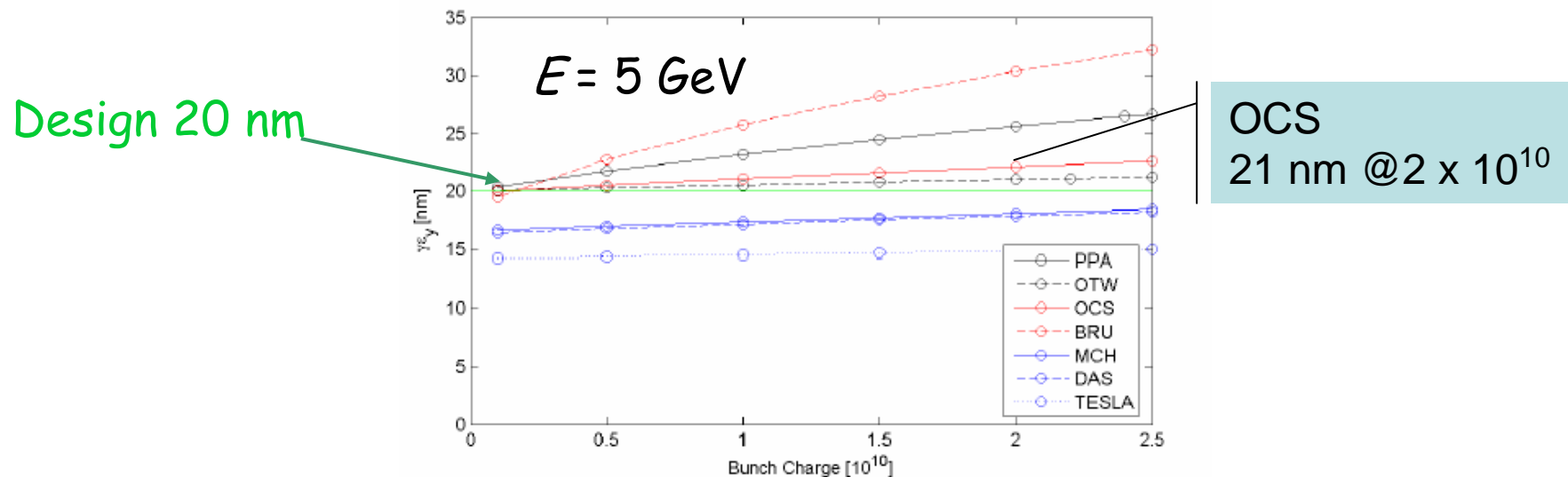



# Fast Ion Instability

- Fast ion instability could be an issue for the EDR
  - short bunch spacing and high bunch density
- Gaps between bunch trains mitigate effect
  - can reduce ion density by factor of 100
- Must verify experimentally that feedback system can mitigate growth
  - digital feedback system, as used at B factories or DAΦNE, can achieve 20-turn damping time
    - should be enough with appropriate gaps in bunch train
  - also need R&D to see if feedback system noise excites vertical emittance



## Other Collective Effects

- Space-charge effects have been examined for candidate DR designs
  - simulations show no vertical emittance blowup for OCS ring
- Microwave instability
  - could affect vertical emittance, especially in “bursting mode”
  - high  $\alpha_c$  for RDR lattice means beam should be below threshold
    - would prefer to lower  $\alpha_c$ , or add higher harmonic, to save RF
    - need to pay attention to minimizing vacuum chamber impedance



## DR R&D Program

- Global DR R&D priorities are purview of the RDB
  - they have prepared overall list of ILC R&D activities proposed by the collaborating institutions
    - and assigned priorities
- Newly formed "S3" task force will revise and update DR R&D list and priorities on ongoing basis
  - comprises DR ASLs + other knowledgeable persons
    - led by **A. Wolski**
  - they will also monitor progress!



# R&D Objectives and Priorities

- Information being collated in R&D WBS structure
  1. Parameter optimization
  2. Beam dynamics (theory and experiment)
  3. Technical subsystem or component development
  4. Test facilities
- RDB prioritizes as Very High, High, Medium, Low
- RDB Very High priority items include
  - low-emittance tuning
  - single-bunch impedance
  - electron cloud studies
  - ion effects
  - injection/extraction kickers



## R&D Status (1)

- Low-emittance tuning
  - still 2x higher than goal of 2 pm
    - ATF results difficult to reproduce
- Single-bunch impedance
  - present lattice has high  $\alpha_c$ 
    - would like to reduce it to reduce RF voltage requirement (cost)
- e Cloud
  - promising mitigation techniques need to be validated
    - otherwise, we may be back to 2 PDRs ☹
- Ion effects
  - need to understand impact, e.g., growth time
    - confirm feedback as cure



## R&D Status (2)

- Injection/extraction kickers (very high priority)
  - low- $Q$  parameters imply 3 ns kicker rise/fall time
    - need to demonstrate technical solution
  - high- $Q$  parameters relax the timing to 6 ns
  - need to evaluate and choose technology
    - need fast rise/fall time plus  $\sim 2$  ns flat top
    - consider stability and reliability also

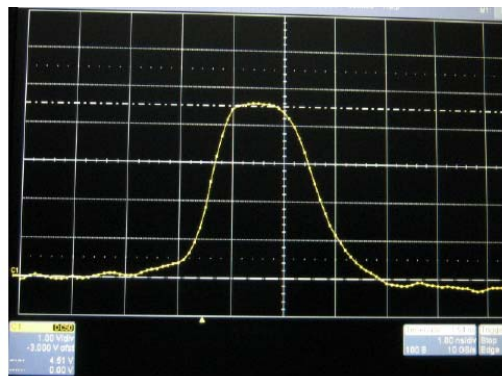

A<sub>out</sub> = 4.5 x 600 = 2,700 V  
Horizontal scale: 1 ns / div  
Waveform: by the LeCroy osc., 10GS/s

Output from Drift Step  
Recovery Diode

1 ns/div

Kardo-Sysoev and Krasnykh

July 2006



## Planning and Coordination

- Need more proactive approach to R&D management
  - presently, just ask institutions for proposals
  - must combine overlapping proposals into coherent plan
    - S3 task force was created to do this (hopefully, by year's end)
  - global R&D coordination is high priority for GDE
- Need to consider role of test facilities
  - ATF, CESR-TF, maybe HERA-DR
    - need for these must be driven by R&D program, not vice versa
- Guiding principles
  - cooperation better than competition
  - flexibility essential (changing priorities and resources)





# Baseline Changes

- Change request has been submitted to CCB to redefine baseline as 1 EDR and 1 PDR
  - possibility of second PDR will be maintained pending R&D on ECI mitigation
    - CCB recommended that EC approve request (awaiting EC okay)
- Second CCR, for central DR complex, in preparation
  - EDR and PDR co-located in one tunnel
    - makes it harder to preserve second-PDR option
  - requires coordination (crosses area system boundaries)
- Changes assessed in terms of cost vs. performance
  - not just cost



# Summary

- DR technical **design and costing progressing well**
  - **we understand what the technical questions are**
    - now we need to get the remaining answers
  - **making progress at cost-performance-risk optimization**
    - single PDR, central DRs
- Confident that we can reach  $\epsilon$  goal
  - **with continued studies (simulations and experiment)**
- R&D plans moving ahead, coordinated by DR ASLs
- Thanks to DR co-ASLs for help with preparing talk
  - **especially Susanna Guiducci**